Table of Contents

CODING AND PROGRAMMING

Subject	Page
What is the Purpose of Coding and Programming.	3
Where is the Data Stored in a Control Module.	4
What is the Difference Between Coding and Programming.	5
Central Coding Key (ZCS).	7
ZCS Structure.	8
ZCS Electronic Storage Locations.	10
Central Coding Code Labels.	10
ZCS Coding Procedures.	11
Other Coding Software Tools.	21
DME Variant Code.	23
Variant Code Structure.	24
Variant Code Identification and Display.	25
Variant Encoding Procedure.	27
DME Variant Codes.	32
DME Control Module Programming.	33
EPROM Replacement and Programming.	34
Control module Identification.	35
Programming Procedure.	36
Programming Procedures for “Customer Service Measures”.	39
Programming Procedures for “Exchange EPROM”.	43
Flash Programming.	46
Procedure for Flash Programming a Control Unit.	47
Review Questions.	51

CODING AND PROGRAMMING

Model: All

Production Date: All

Objectives

After completing this module you should be able to:

- Recognize the differences between Coding and Programming.
- Understand how the ZCS is stored in the instrument cluster.
- Describe the procedure and software used for ZCS coding control modules.
- Explain what occurs during DME Variant Coding.
- Describe how to identify the Variant Code of a DME control module.
- Describe the procedure to re-program a DME with a removable EPROM.
- Know how to read a DME identification label.
- Review the various tools available in the Coding and Programming software.

What is the Purpose of Coding and Programming?

Coding and programming allows a reduction in the number of control module hardware versions by providing a means of electronically writing the operating instructions to a blank or base control module. As a manufacturer of vehicles for world-wide distribution, BMW must produce several variations of control module versions to satisfy various requirements due to:

- Country specific regulations
- Equipment level
- Powertrain configurations

Before workshop coding and programming was available this process was only performed by the factory. Factory programming equipment loaded a basic set of operating instructions into a blank control module. The base system was common for all vehicle markets. Additional specific data was then added to the basic system producing country and vehicle specific variants of the control module.

As the number of control modules in a vehicle increased, so did the number of control module variations necessary for spare parts sales. This produced bulging inventories of similar hardware that only differed in the way that they were coded.

Coding and programming is the solution to this problem of expanding parts inventory and costs. Advantages to workshop coding and programming are:

- Fewer control unit hardware versions.
- Lower parts and inventory costs.
- Updating of software changes possible (Re-coding and Service Measures).
- Addition of special equipment features to existing control units (e.g. DWA).
- Customization of vehicle operation (e.g. Conversion and VKM).

There are several different methods used to provide operating instructions to a control module. The methods are determined by the vehicle, model year and type of control module.

BMW uses the following methods of control module encoding:

- Central Coding Key coding (ZCS).
- Vehicle and Key Memory coding (Referred to as Car and Key memory in coding software. Car and Key Memory is explained in the Technical Systems course).
- DME Variant Coding.
- DME Eprom Programming.
- Flash Programming.

Where is the Data Stored in a Control Module ?

One of the differences between a personal computer and a vehicle control module is where the data is stored. The computer uses a hard drive, while a vehicle control module uses either an EPROM or an EEPROM depending on the system.

EPROM (*Electrically Programmable Read Only Memory*)

An **EPROM** is a removable chip with multiple connector pins which plug into the printed circuit of the control module.

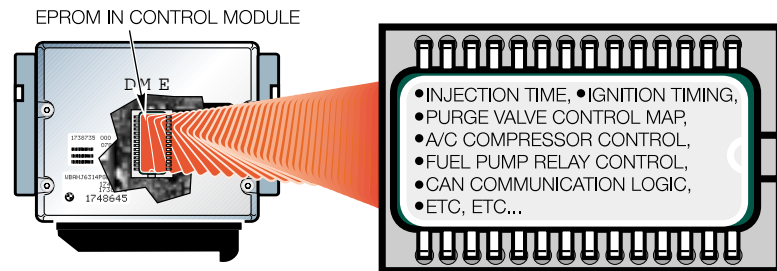

When re-programming this type of control module, the EPROM must be removed and a new “blank” EPROM installed prior to programming.

EEPROM (*Electrically Erasable Programmable Read Only Memory*)

An **EEPROM** is a soldered in chip which is not removable from the control module. As their name implies, EEPROMS can be electrically erased and reprogrammed without opening the control module. This is known as “**Flash Programming**”.

In either case, the E or EE PROM stores the loaded program data including:

- Characteristic maps for; Ignition, Injection, Purge control, etc...
- Characteristic curves
- Control constants



What is the Difference Between Coding and Programming?

Coding

Coding selects a set of instructions that are already present in a control module. When a codable module is ordered from the parts department it contains all of the programs necessary for any applicable vehicle version.

The programs are stored in an EPROM as “Resident Data”. During the coding process one set of instructions (e.g. USA version, equipped with board monitor, high cluster, etc.) is activated in the control module. Coding is used for most control modules in the vehicle except for powertrain control modules.

The various types of coding methods are:

- ZCS Coding.
- Coding Code (no longer supported).
- Variant Coding (DME).
- Vehicle and Key Memory Coding.

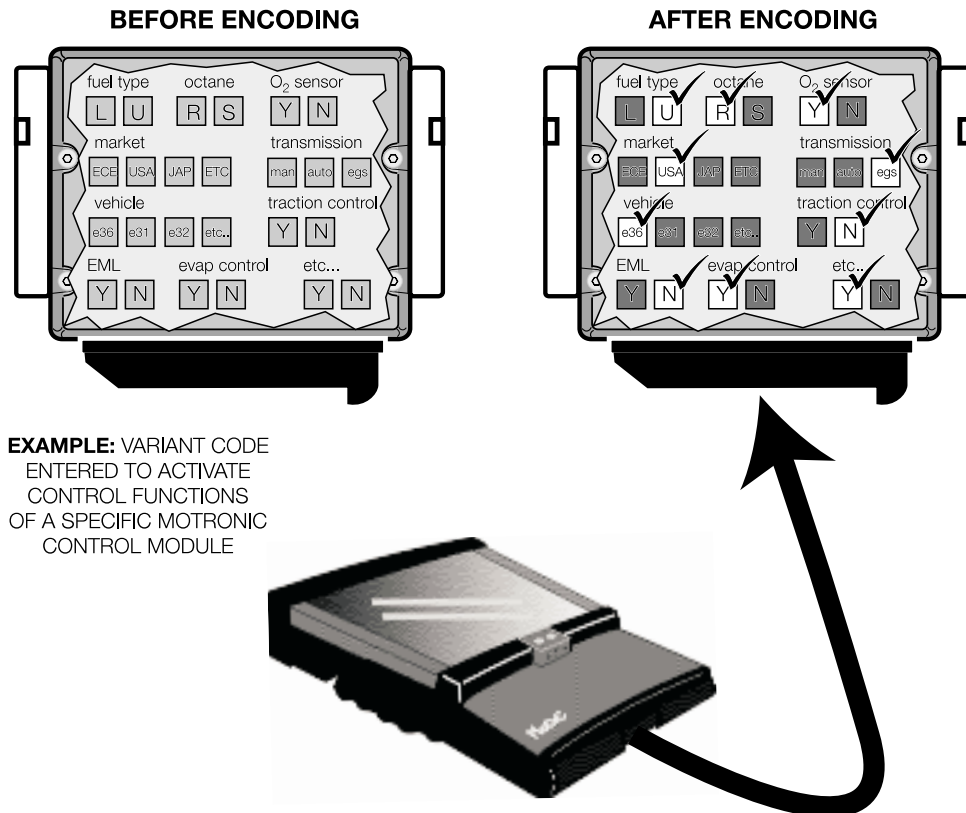

Programming

Programming is entirely different than coding. New programmable control modules contain information about the identity of the module but do not have any pre-written instructions.

During the programming operation, the appropriate specific data maps (e.g. ignition maps, fuel delivery maps, shift points, etc.) are written electronically into the EPROM of the “basic control unit”. The programming data is commonly referred to as the “part number for a programmed control unit”. This part number corresponds to a very specific data set.

There are two types of basic control modules: Programmable and Flash Programmable.

Programmable control modules may have instructions written to the EPROM only once. If the data set needs to be changed the EPROM must be removed from the module and replaced with a new blank one.

The EEPROMs of flash programmable control modules are soldered in and are not removable; however, they can be electronically erased and written to multiple times (14).

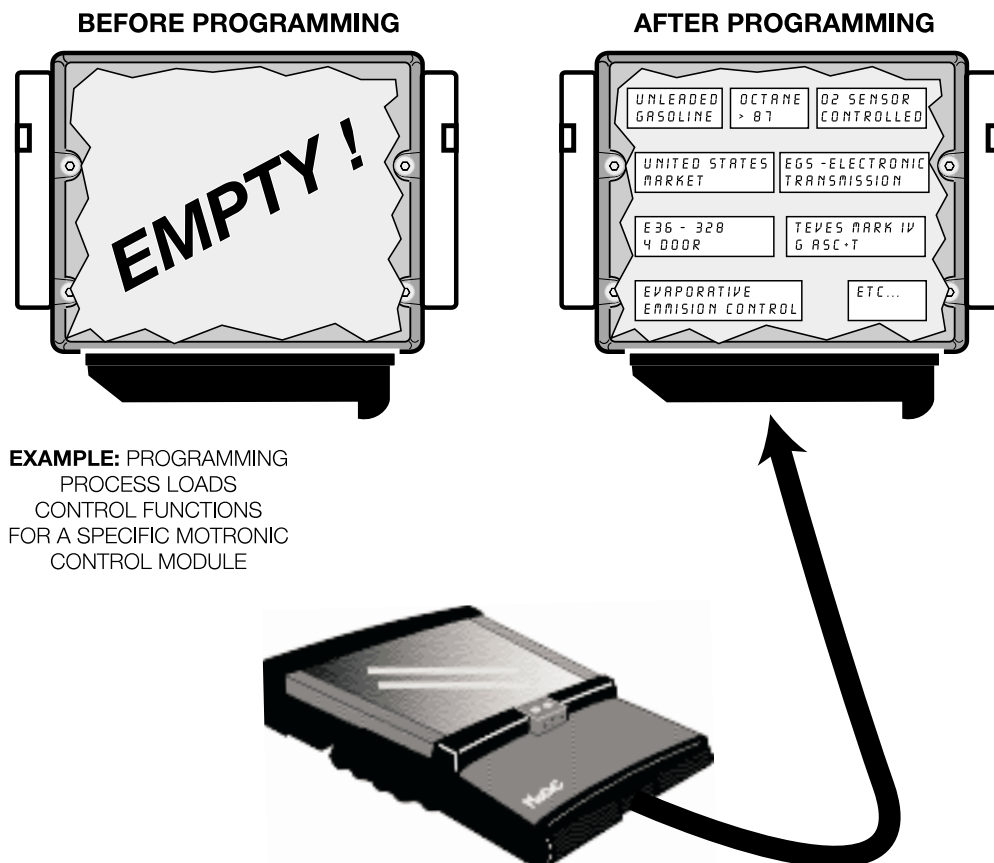

Central Coding Key (ZCS)

The Central Coding Key is a unique 37 digit code (originally 48) that contains all model and equipment information of the vehicle that is relevant to coding. The ZCS code for a particular vehicle is created by the factory, based on the individual equipment and country version of the vehicle. The encoding equipment at the factory duplicates the ZCS and encodes the installed control modules in the vehicle after assembly.

The ZCS code is stored in one or two modules (vehicle dependent). This code is retrieved by the coding software of the DISplus or MoDiC whenever coding of other control modules is necessary.

The coding process for modules that are encoded by the ZCS occurs by selecting or activating data maps already contained in the control module. The control modules have an EPROM that is pre-programmed with “resident data”. There is more information (data) than is necessary to operate the control module. This data is ready to be activated as soon as the Key is made available to “unlock” the program. ZCS is called a key because it unlocks a specific set of instructions of a new control module or recodes a used control module.

Prior to coding a control module, the coding software checks whether the stored ZCS code, the coding data and the version of the control module agree. If these deviate from each other the coding program will determine a new “Central Code”.

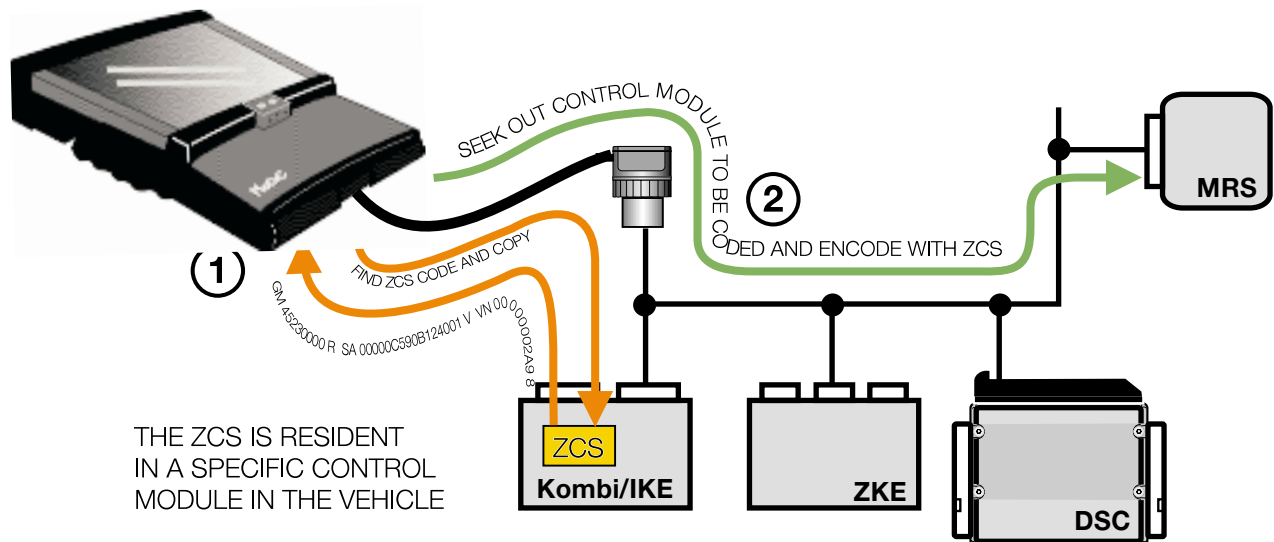

Use of the Central Coding Key began with the introduction of the E31 in 1990.

A ZCS codable control module may be coded an infinite number of times.

ZCS Structure

The Central Coding Key is 37 digits and is divided into 3 segments. The segments represent specific information about the vehicle.

Each segment ends with a “check digit”. A check digit is a number or letter used by the coding software to detect unacceptable or implausible codes.

The segments of the ZCS are:

GM = Basic Features

The 9 digits of the GM describes:

- Type of vehicle (E38, E46 etc.)
- Body style
- Body equipment
- Country version
- Basic language

GM 5E3300006

SA 2020049006864414W

VN 1010000082Z

SA = Special Equipment

The 17 digits of the SA describes:

- Vehicle equipment
 - Power windows
 - Sunroof
 - DWA
 - FZV
 - Xenon lights
 - Headlight washers
 - DSC, etc.

VN = Version Number

The 11 digits of the VN describes:

- All data relevant for coding which are not Basic Features or Special Equipment. (E.g. model year dependent data, software and hardware versions, coding instructions, etc.)

Originally the ZCS code also contained a fourth line called **AM = Drive Management**. This 11 digit code was supposed to contain information specific to powertrain control modules. The AM was never used and was deleted from the central coding label early on.

FOUR DIGIT PORTION REPRESENTS VEHICLE BODY AND SPECIFIC BODY EQUIPMENT
(COUPE, SEDAN, ROADSTER, SUNROOF, ETC.)

There are 4096 possible combinations of digits per model.

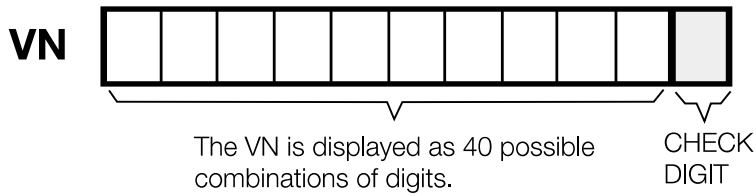
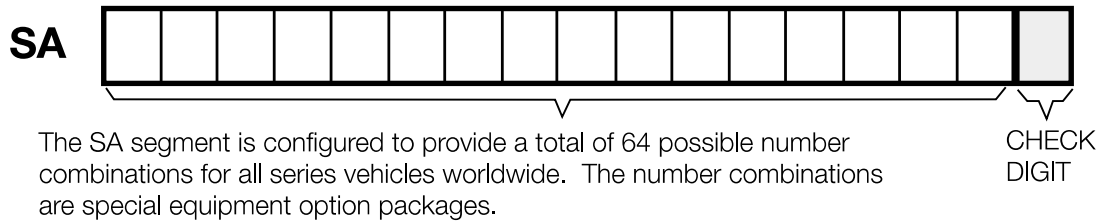
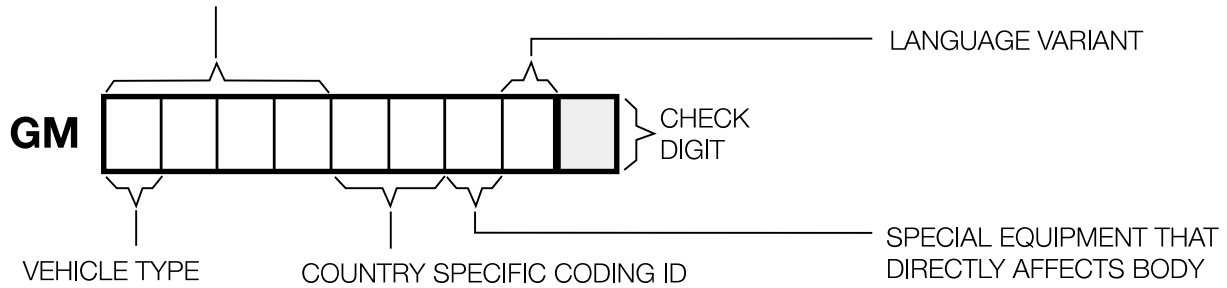

ZCS Electronic Storage Locations

A master copy of the ZCS is stored in the vehicle electronically to provide the coding software a source for retrieval. The ZCS code is stored in the Instrument cluster or EKM and redundantly in the EWS module on vehicles produced from 1/95.

On vehicles that did not have a diagnostic link to the cluster (E36/5 and E36/7 up to 9/98) the ZCS was only stored in the EWS.

The ZCS code may be read out and printed using the DISplus/MoDiC coding software.

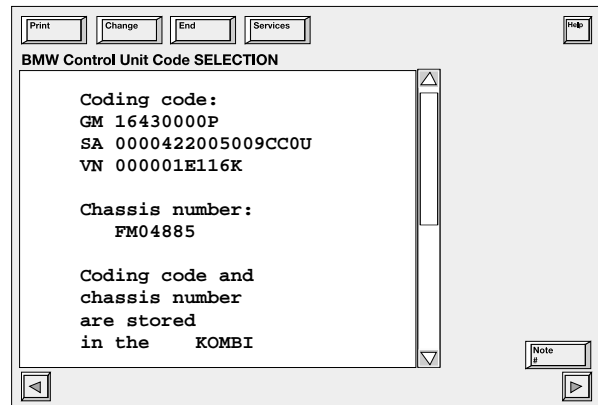

Central Coding Code Labels

A label printed with the ZCS code was used as a back-up to the electronic version stored in the control modules. This back-up was necessary particularly on vehicles which had the ZCS stored in only one control module.

The ZCS label was eliminated from all vehicles except the 318ti and Z3 starting with late 3/98 production. The 318ti and Z3 had the labels eliminated as of 9/98 once the instrument clusters were linked to diagnosis.

The storage locations of the labels are as follows:

- E31/E32/E34: inside the fuse box cover.
- E36: up to 9/93 under the rear seat in the center. After 9/93 on the cover for the left side fuel sending unit.
- E38: inside the E-box cover.
- E39: in the right side of the trunk next to the battery.

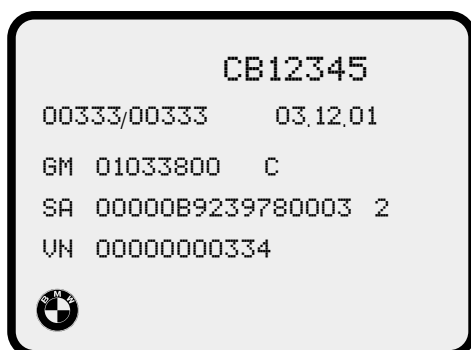

ZCS label

ZCS Coding Procedures

The ZCS coding procedure is done using the Coding and Programming application of the DISplus or MoDiC. There are two methods of coding replacement control modules:

- Automatic coding (ZCS code is automatically retrieved)
- Manual input of ZCS

Automatic ZCS Retrieval and Coding of Control Modules

Control units which store the ZCS code(Instrument cluster, EWS) require that the data be transferred out of the faulty module to the coding software first before automatic coding can continue. If the defective control module cannot communicate with the coding software then coding would have to continue manually.

After installing a replacement module the software searches for all ZCS codable modules according to the stored ZCS code.

The ZCS is copied by the coding software and stored in memory. The program extracts the necessary information from the copied ZCS and generates coding data for the exchanged module. The coding software automatically sends the data to the control module which codes it for a particular vehicle version

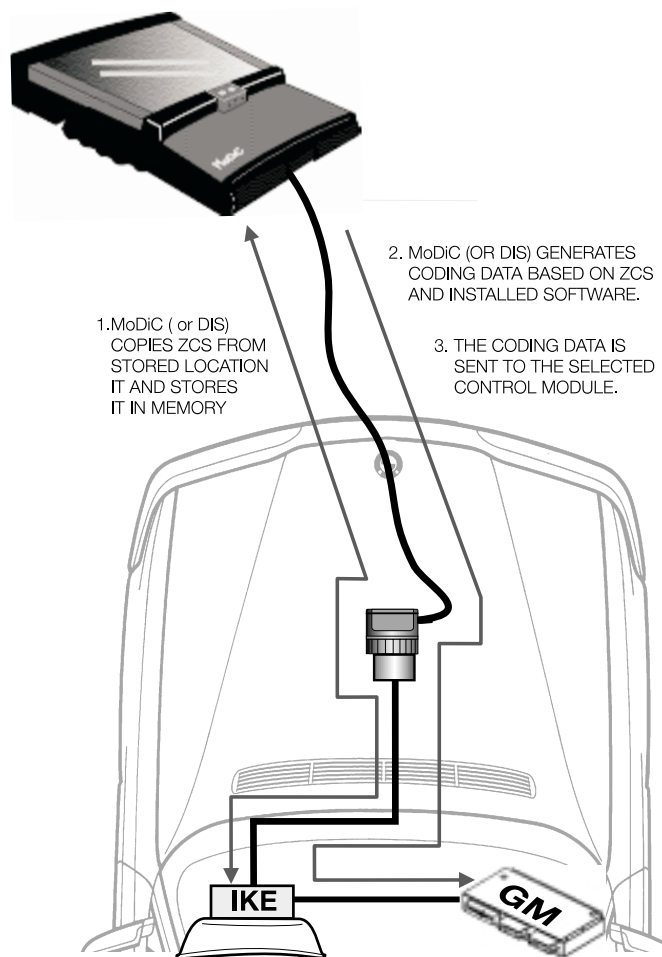

Vehicles that have Vehicle and Key Memory capabilities modify the ZCS code in a particular module to enable certain features.

When recoding or replacing a module the ZCS will be restored to the basic settings and individual changes to the code will be lost, as well as the modified functionality.

To prevent from returning a vehicle to a customer without the VKM selections, always use the "Print List" option of the Vehicle/Key memory menu.

Verify from the list that any changes made are restored to the vehicle.

Automatic Coding Procedure

Always have a battery charger connected when using diagnosis or coding equipment. Voltage should be stable at 12.5 V.

Example used is coding an E39 instrument cluster.

1. With the old control module still installed, connect the DIS/MoDiC to the diagnostic socket. Turn the ignition switch on.
2. Select Coding and Programming from the DIS/MoDiC start screen or “Change” drop down menu.
3. Select “3 ZCS CODING” and press the continue arrow (right arrow button).
4. The Version ID page is displayed. Verify that the latest coding software is being used. Press the continue arrow.
5. Note the warning about Car/Key Memory and select the appropriate series.

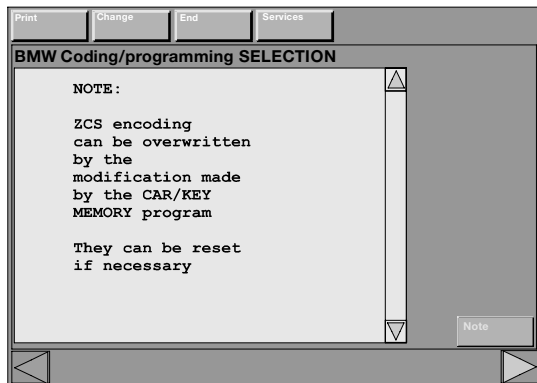

6. The next screen provides five options
- Select recoding, the other 4 options will be discussed at the end of the ZCS coding section.

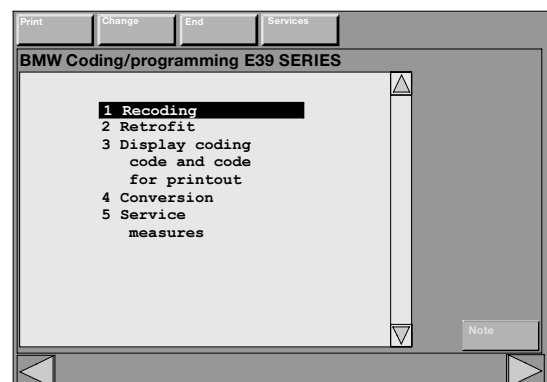
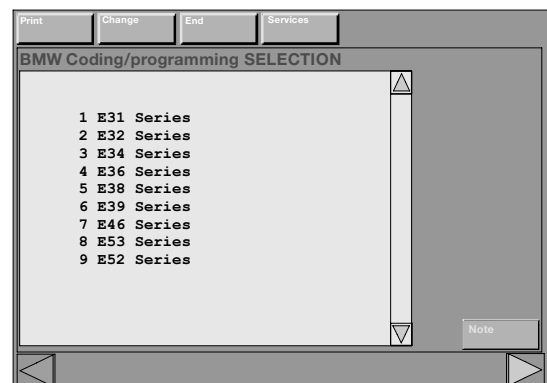
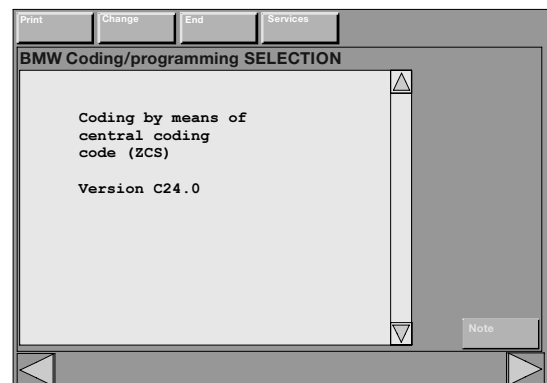
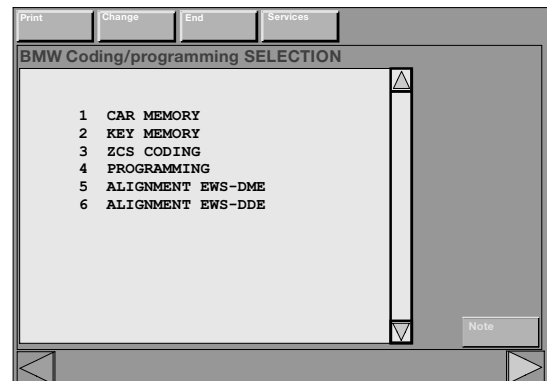

7. The following screen provides a list of all ZCS codable modules according to the stored ZCS code.

Select the module to be replaced or recoded and press the continue arrow.

Confirm that the correct module has been selected by pressing the “yes” button and then the continue arrow.

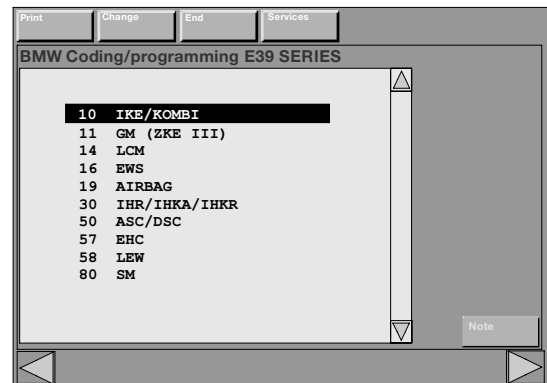

8. Select the correct procedure to be performed. If the module is going to be replaced select “replace control unit”. If the coding is to take place on the existing control unit select “recode control unit”.

For the example “Replace control unit” is chosen.



9. The following step requires that the faulty control unit still be installed in the vehicle. The coding software reads the ZCS data out of the module and saves it in memory.

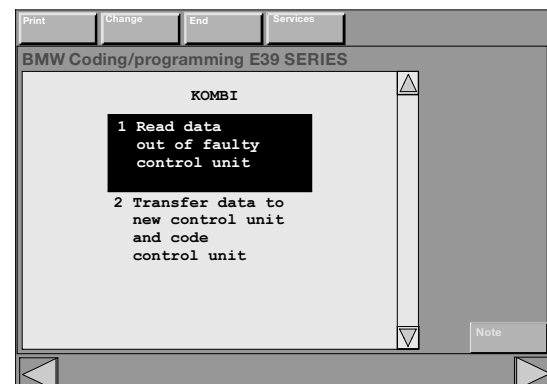
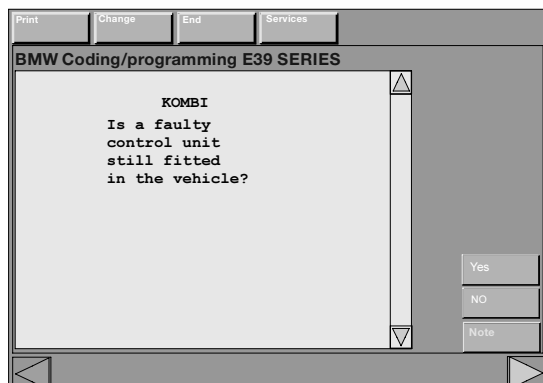
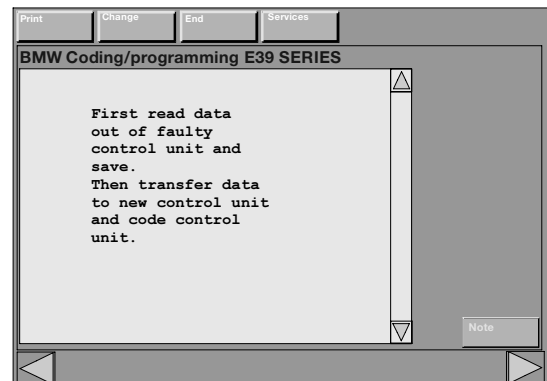

10. After the data is read from the faulty control unit the software will store the data and request that the new component be installed.

Before coding the new part, confirm the vehicle identity by entering the chassis number. This entry recalls the data stored in the DIS/MoDiC from the faulty control unit.

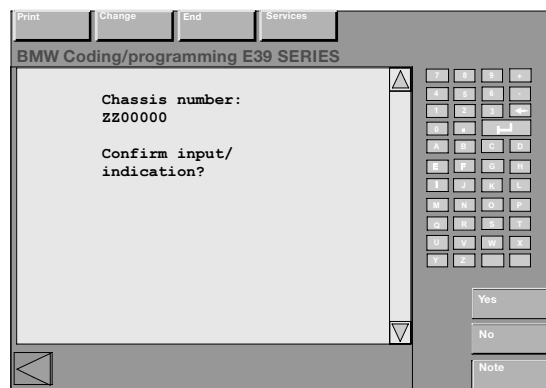
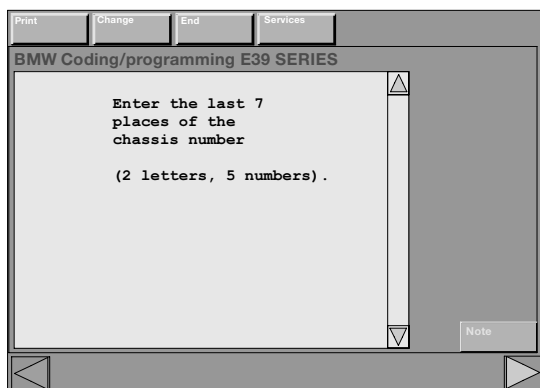
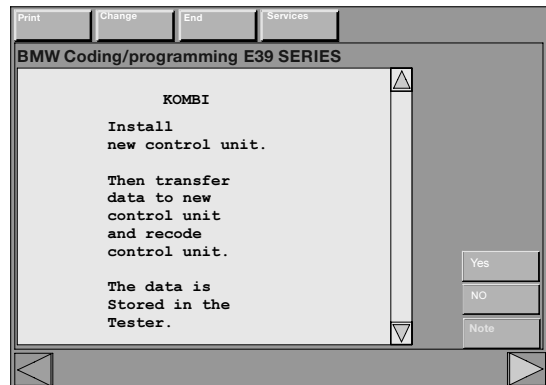

11. Select "Transfer data to new control unit and code control unit".

The following screen will then request that the control unit be installed and the key be turned on.

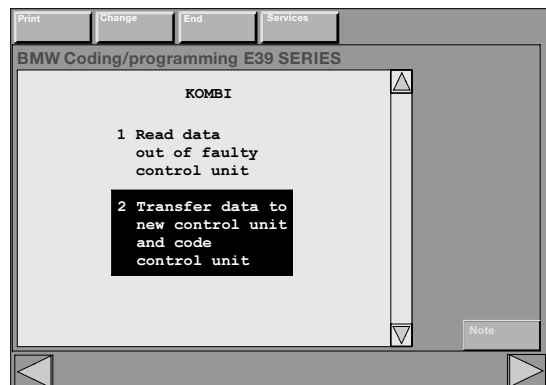

12. Note the warning that some displays or operation may change from what is normal for that country or vehicle version (e.g. display in Celsius or Fahrenheit). If changes need to be made they may be done after coding by using Conversion.

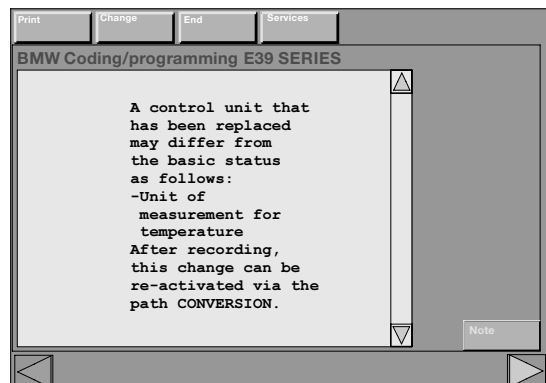

13. When coding the instrument cluster, EKM or LCM/LSZ the coding software will ask if the component should be rigidly assigned to the vehicle. Assigning the component permanently writes the VIN to that component.

If the part is only being used for testing purposes select "no".

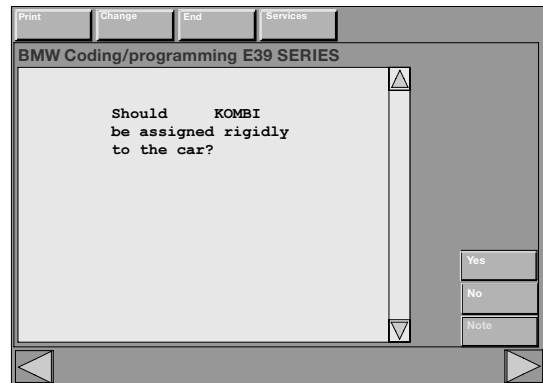

14. Verify that the chassis number and ZCS code are correct. If any changes need to be made select "yes" and a keypad will appear on the right side for manual entry.

If the information is correct chose no and continue with the right arrow.

Start automatic coding by selecting "yes".

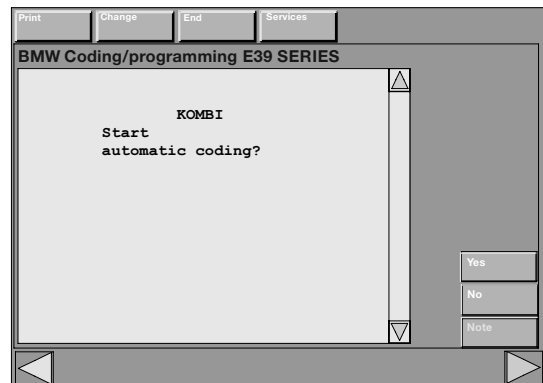
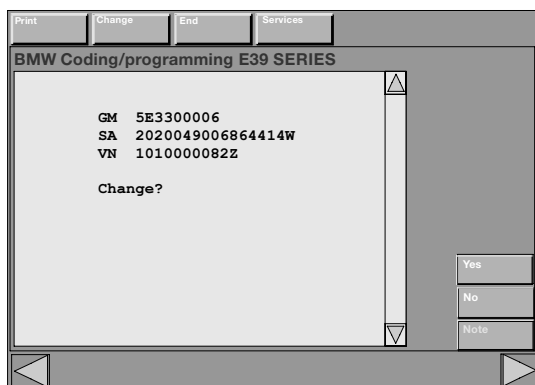
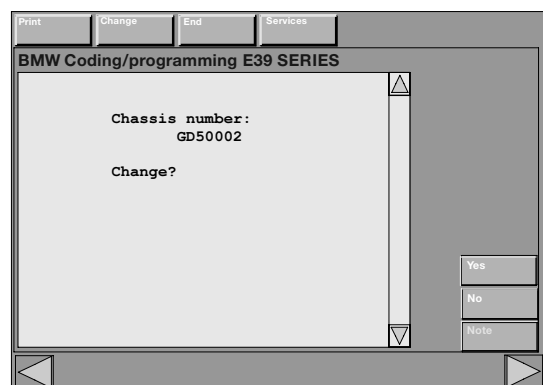

15. The final screen will acknowledge that coding was successful and if the ZCS code was changed. Changes in the code are made if the coding software and control module software and hardware are modified from the original combination. On vehicles that utilize a label a replacement label should be made and placed next to the original and the original crossed out.

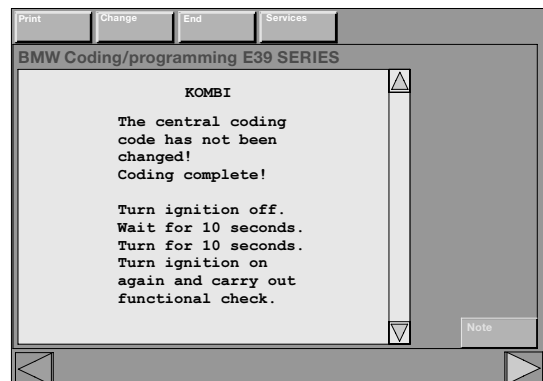

Manual Input of ZCS Code

Currently when replacing control modules that store the ZCS code (IKE/KOMBI and EWS) the code is read out from the faulty module and stored for later coding. When replacing modules that store the ZCS on earlier vehicles, it requires that the code be read from the vehicle ZCS label and entered manually.

The control modules that require manual input are:

- IKE (E38 up to 1/95)
- EKM (E31)
- Instrument cluster (E32/E34 after 9/91 and E36)
- EWS II (E36/5 and E36/7 up to 9/98)

For later vehicles, as long as the defective module can communicate automatic coding is possible. If the data can not be read (module cannot communicate) then the ZCS code will be retrieved from the redundant location.

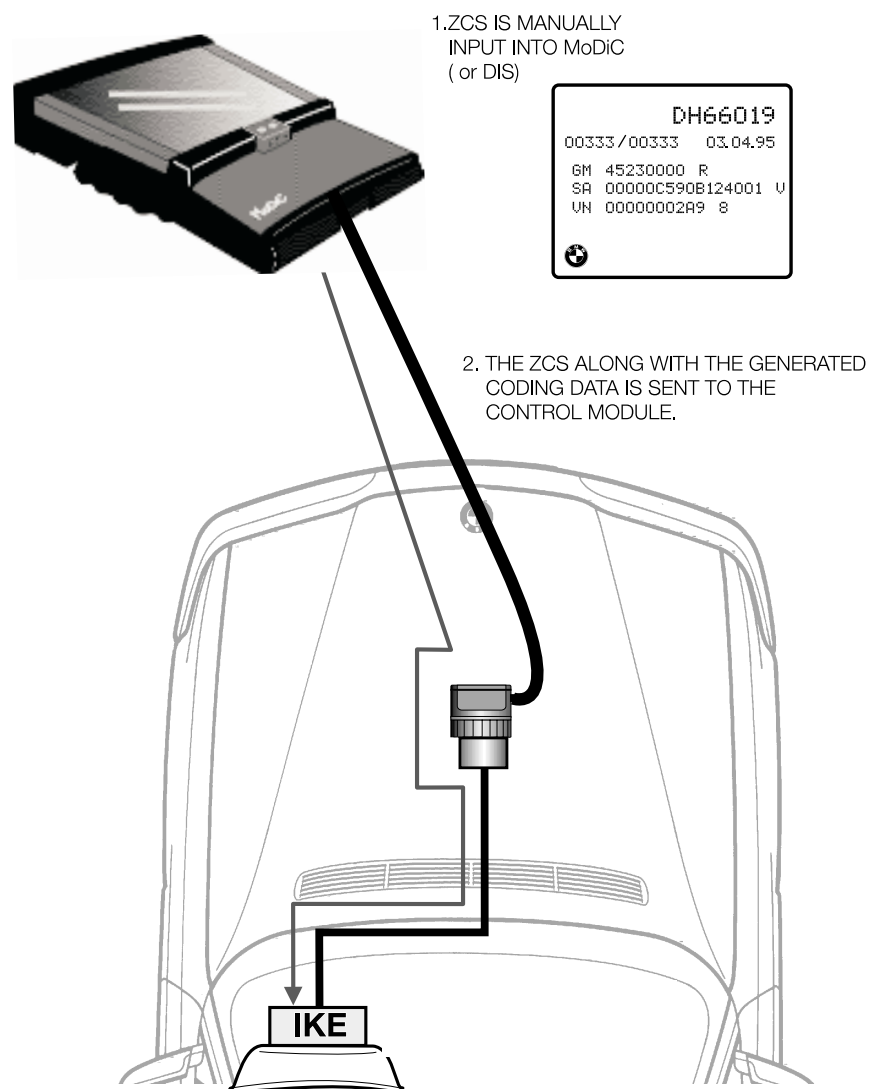

Manual ZCS Coding Procedure

Always have a battery charger connected when using diagnosis or coding equipment. Voltage should be stable at 12.5 V.

1. With the new control module installed, connect the DIS/MoDiC and turn on the ignition switch.
2. Select Coding and Programming from the DIS/MoDiC start screen or “Change” drop down menu.
3. Select “3 ZCS CODING” and press the continue arrow (right arrow button).
4. The Version ID page is displayed. Verify that the latest coding software is being used. Press the continue arrow.
5. Note the warning about Car/Key Memory and select the appropriate series.

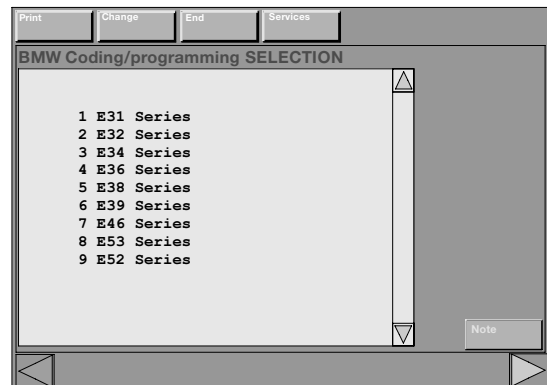
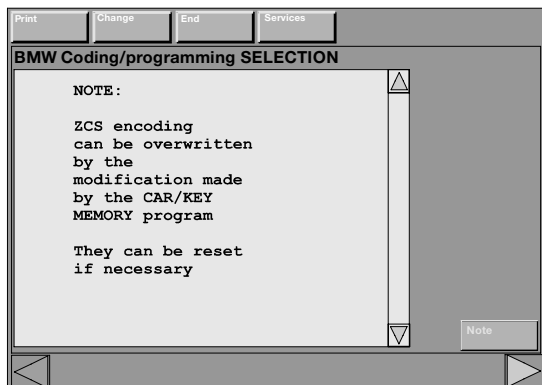
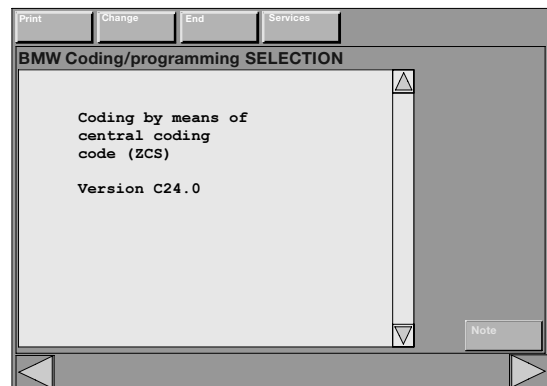
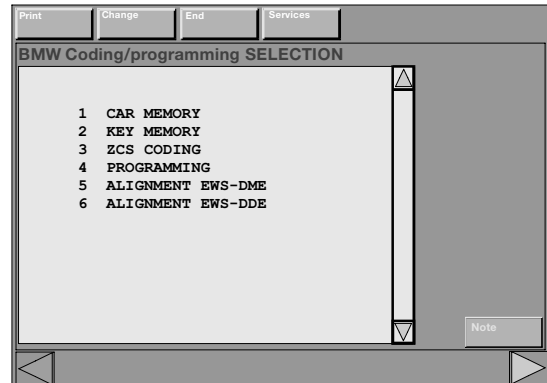

6. The next screen provides five options
Select recoding.

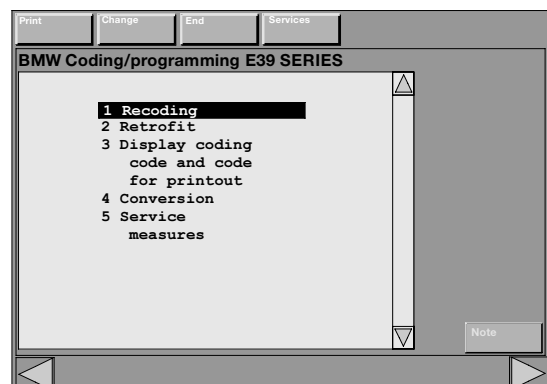

- The next screen lists the connected ZCS codable control modules installed in the vehicle.

Select IKE/KOMBI or EWS which are the only ones that require manual entry.

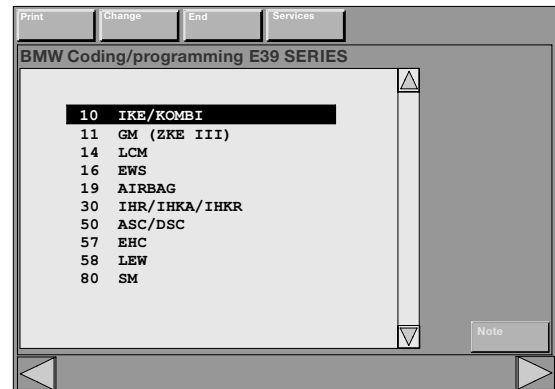

- The next screen then responds by asking if the selection is correct. Press the "Yes" button and continue.

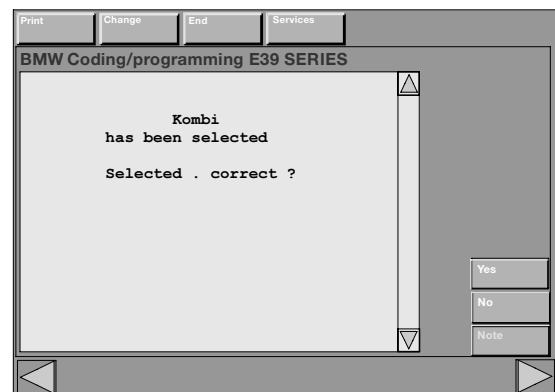

- The next screen displays the last 7 digits of the chassis number in the cluster. Since this is a new replacement control module it is displaying the basic information (FFFFFFF) which does not have a specific VIN assigned to it yet.

Enter the last 7 digits of the vehicle identification number using the keypad. When finished double check the display and confirm the input by pressing "Yes".

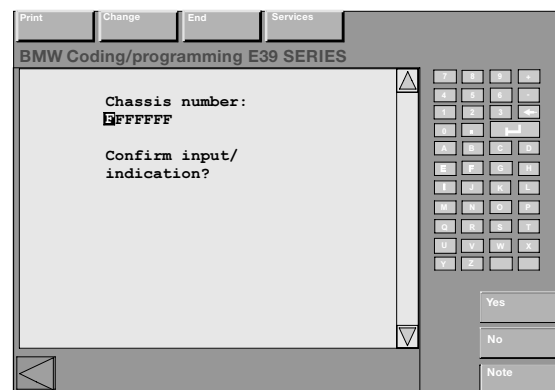

- With the last 7 digits of the VIN entered, the present ZCS code is displayed on the screen. All positions of the ZCS are "F" which indicates the control module is still in the basic state.

The display requests a YES or NO response to change the displayed ZCS. Press the YES button to continue.

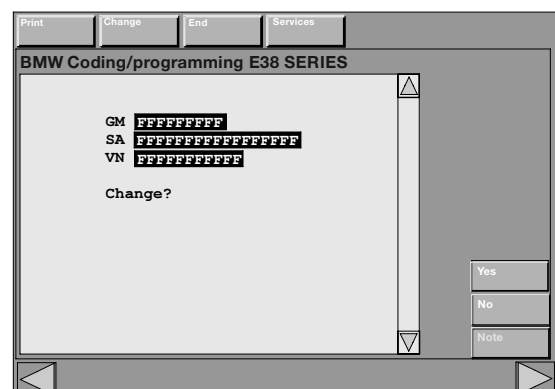

11. The GM segment is displayed (FFFFFFFF). Press the “No” button to refuse display.

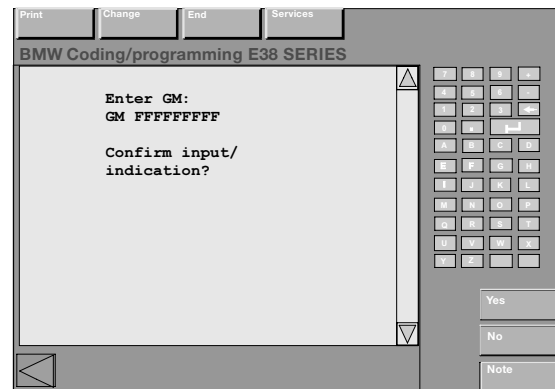

12. The next screen displays an expanded keypad for complete entry of the GM segment. This is read from the label of the vehicle.

Carefully enter the complete GM segment, double check all digits as displayed and press the “Yes” button when complete.

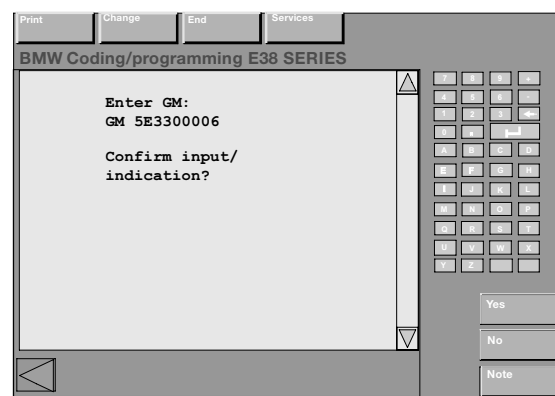

13. The next two screens are for entry of the SA and and VN segments.

Enter these numbers in the same manner they were entered for the GM segment.

Double check all digits and Press the “YES” button and continue.

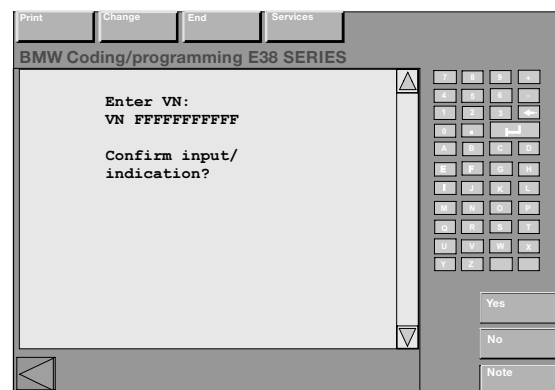
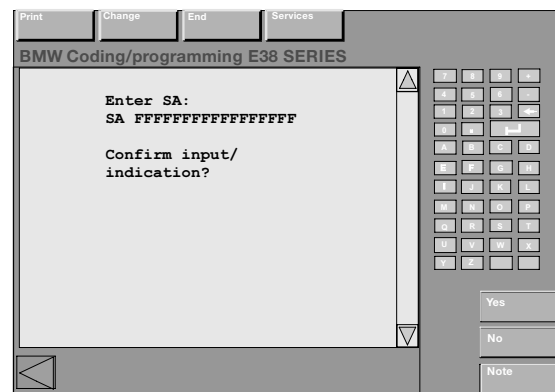

14. The next screen indicates that the ZCS has been entered into the DIS/MoDiC and automatic coding is ready to start.

Press the "Yes" button and then continue.



15. The screen indicates that Automatic Coding is Active.

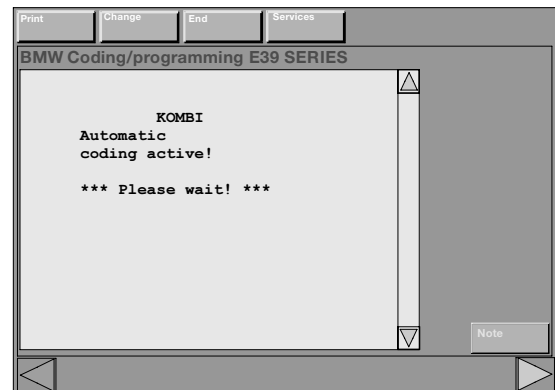

16. The next screen displays the encoded ZCS.

As noted on the screen the ZCS has changed from the basic uncoded state. Changes to the original ZCS code occur because either the coding software or hardware version of the control module is different.

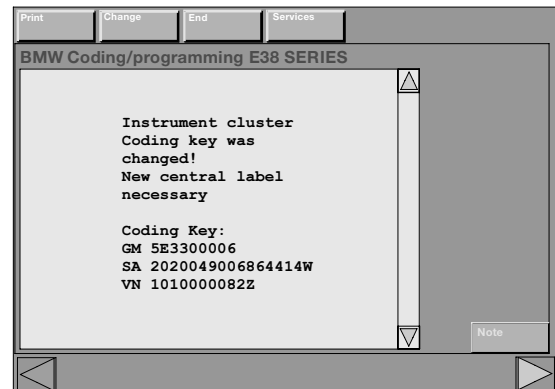

17. The next screen displays "coding key stored for printout. If necessary write out a new ZCS label and affix it into the vehicle specific location.

Coding is completed, Switch off the ignition and wait for 10 seconds. Switch on ignition and check for proper system operation.

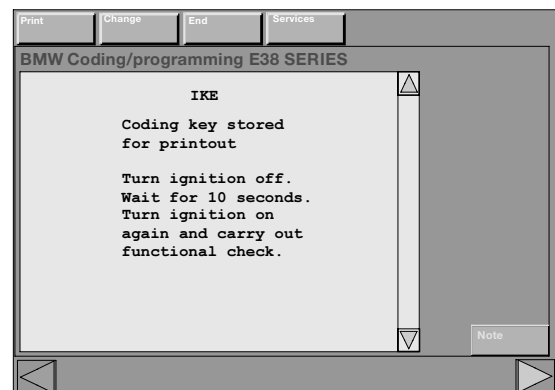

Other Coding Software Tools

Retrofit

Retrofitting allows options or equipment to be added after the vehicle has been produced or sold.

Retrofit changes the existing ZCS SA to include the upgrade or complete system that has been added to the vehicle.

e.g. The DWA system for E46 vehicles may be purchased from a BMW center parts department as an equipment upgrade. Retrofit is used to modify the ZCS so that the GM V will properly operate with the newly installed components.

Display of ZCS for Printout

This selection from the ZCS coding menu displays the coding code as well as the stored chassis number of the vehicle.

The information is displayed so that a print out can be made of the original code. Having the original code is useful if the vehicle needs to be returned to the original state when retrofitted items are removed or just to view what the code is to verify status.

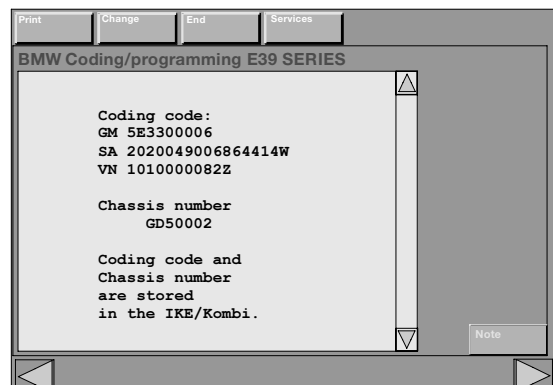
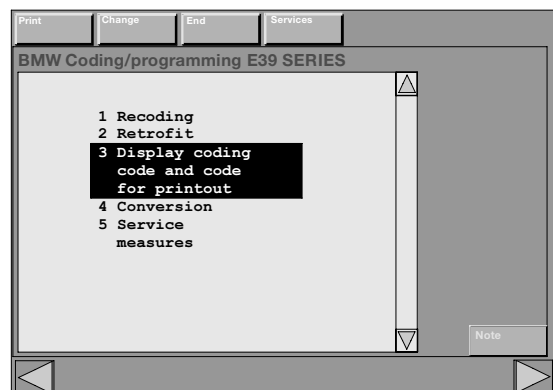
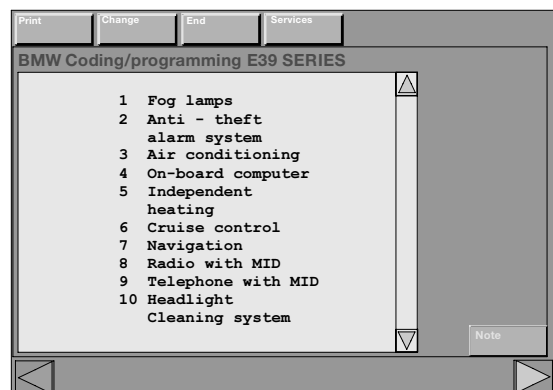
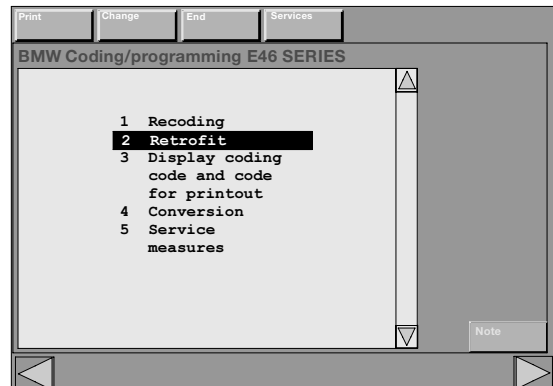

Conversion

Conversion allows specific functions of a control module operation to be changed much the same way Car and Key Memory is used to customize a vehicle.

The coding software will compose a list of modules with conversion possibilities based on the model variant.

Conversion changes the code only in the module that is responsible for the changed function.

The stored ZCS code is not affected and recoding that particular module again will return the module to basic status and reverse the effects of the conversion process.

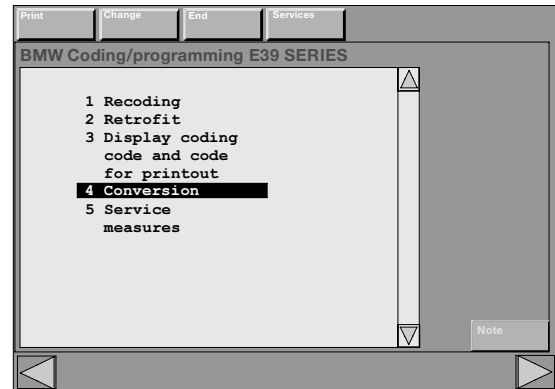

Service Measures

Service Measures are software solutions for vehicle problems that have been identified in the field.

The coding software compares the ZCS code of the vehicle to a data base for specific system versions (e.g. module hardware and software versions) that qualify for the update.

The determination is done automatically and the DIS/MoDiC communicates to the Technician whether a Service Measure is necessary or not.

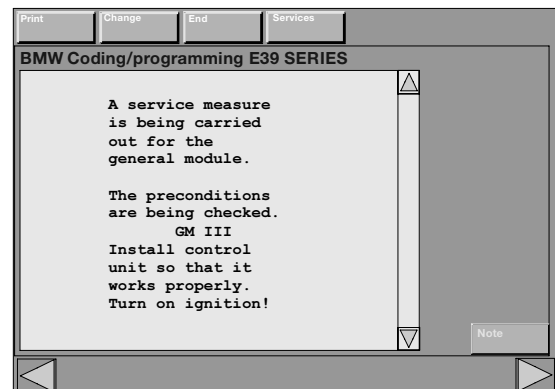
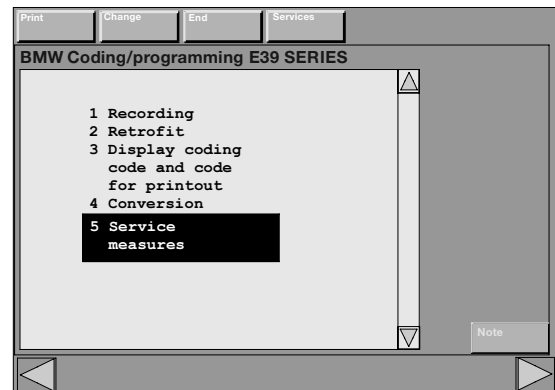

DME Variant Code

The variant code is a 4 digit hexadecimal (alpha-numeric) code. Like the ZCS, the variant code activates the specific market required functions of the control module. The variant code is stored in the control module once it is encoded.

Variant coding through the DIS/MoDiC applies to all M1.X (e.g. M1.3, M1.7, M1.7.2 etc.) DME control modules. **M1.x DME control modules are the only DME control modules that are variant encodable.**

Using the DIS/MoDiC with the DME Programming software allows the technician to:

- code a new, uncoded control module.
- recode a previously coded control module.

The variant code is entered into the control module either by:

- Adopting the existing code from the defective DME control module (if diagnostic communication is possible).
- Manually entering the variant code.

The code generates the coding data in the DIS/MoDiC and is downloaded to the DME control module. The specific vehicle information relevant to that particular engine group is activated and the control module is ready for use.

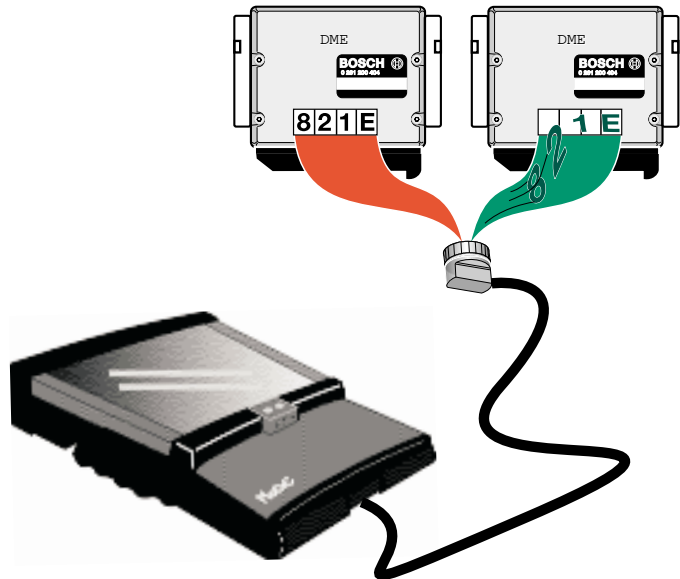

M1.X DME control modules can be coded up to eight (8) times. The DIS/MoDiC displays the remaining number of times the control module can be recoded.

The DME variant code should be checked and verified as correct when troubleshooting driveability complaints. An incorrectly coded DME will create unusual and difficult to diagnose problems.

Variant Code Structure

The four digit structure of the variant code is a two word hex code. Each hex character provides specific control module encoding information

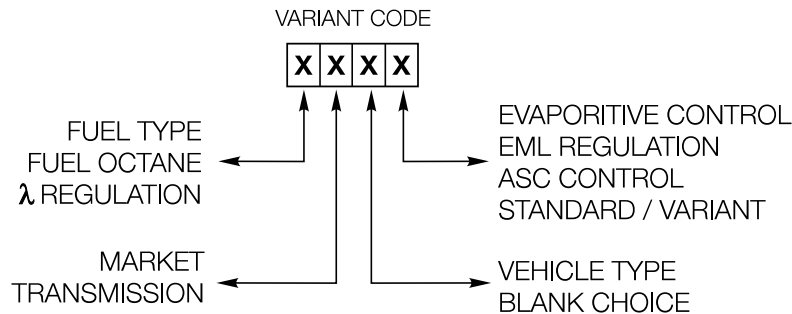

Each hex digit has a binary equivalent that provides four 1s or 0s. This provides a total of 16 bits of information (or choices).

The control module assigns specific functions, characteristic maps and control module program constants based on the individual 1s and 0s.

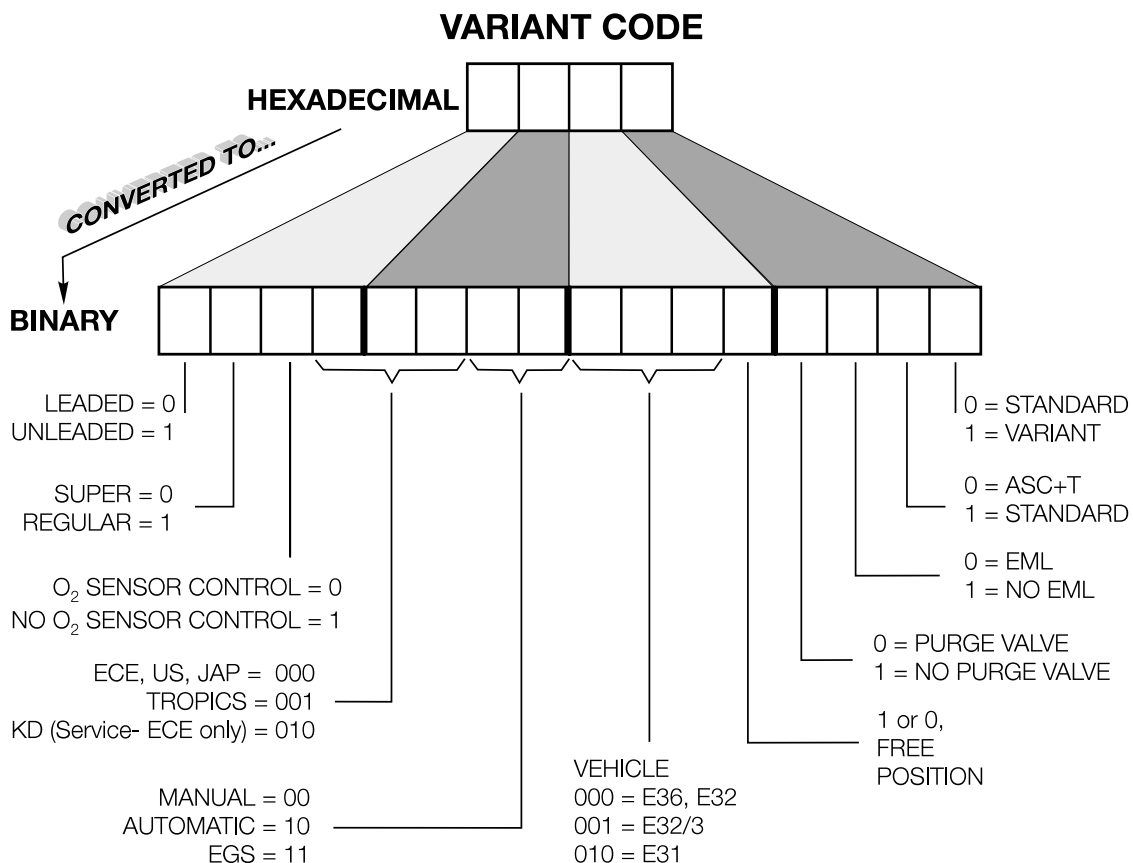

Intentionally miscoding a DME will not create any performance advantages and quite possibly could lead to engine damage.

Variant Code Identification and Display

The variant code for a DME M1.X control module can be displayed in three places.

- Electronically displayed
 - Control module Identification page of the DIS or MoDiC diagnosis software.
 - Programming software display with MoDiC. In the “adopt code” function, installed variant code is displayed.
- DME control module variant code label.
- Service Information Bulletin 13 02 90.

The control module ID page of the DIS is the quickest method of viewing the installed variant code. Electronic display is also the most accurate (code determination by the label could be an incorrectly written or accidentally placed on the wrong control module.)

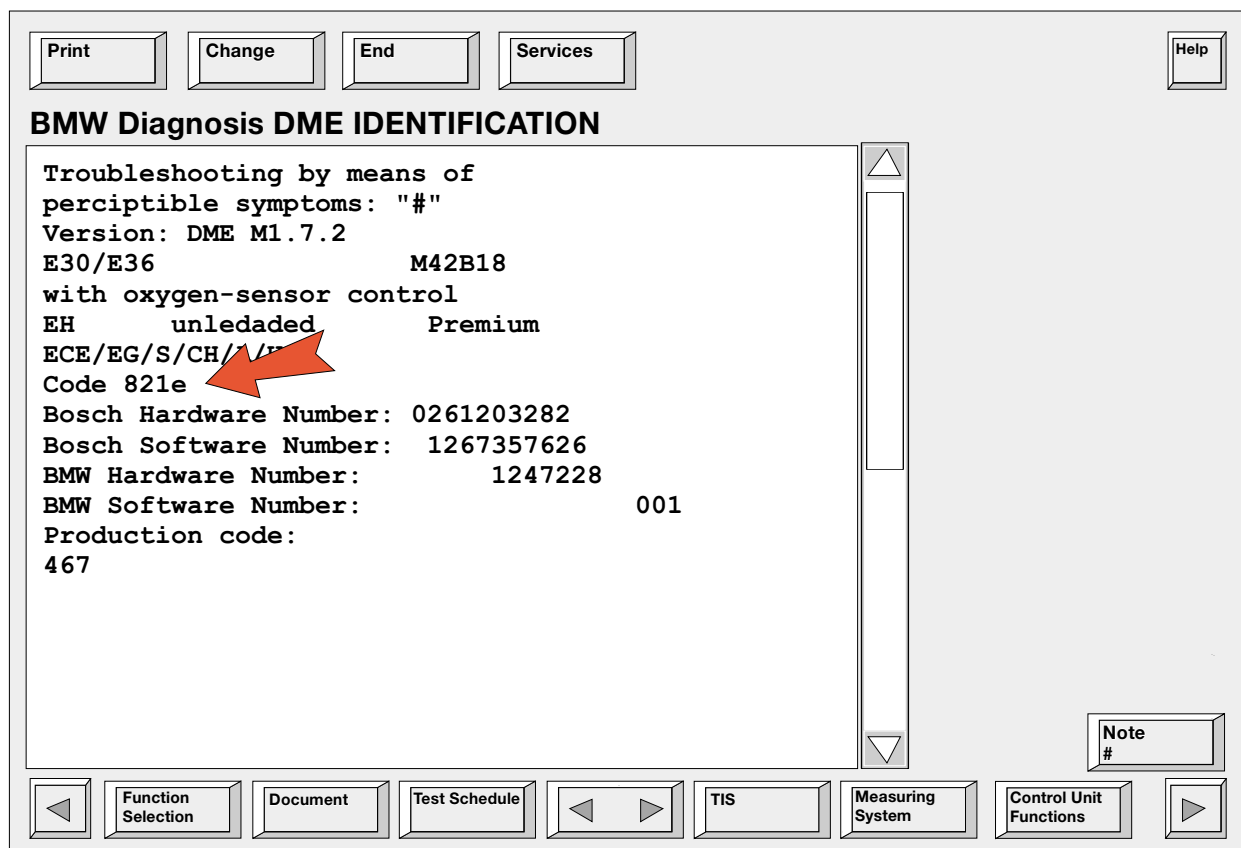

Cross reference the BMW and Bosch part numbers in the display with the installed variant code. The correct variant code installed in the wrong control module, or an incorrect variant code installed in the correct control module, will undoubtedly cause control module malfunction.

Variant Encoding Procedure

If a DME M1.X control module replacement is required, determine which method of variant encoding you can use.

- Adopting variant code from existing control module
- Manual input of variant code from control module label

Adopting the code is the preferred method since it prevents any error when manually entering the code. If the control module cannot communicate on the diagnostic link the manual input method will be necessary.

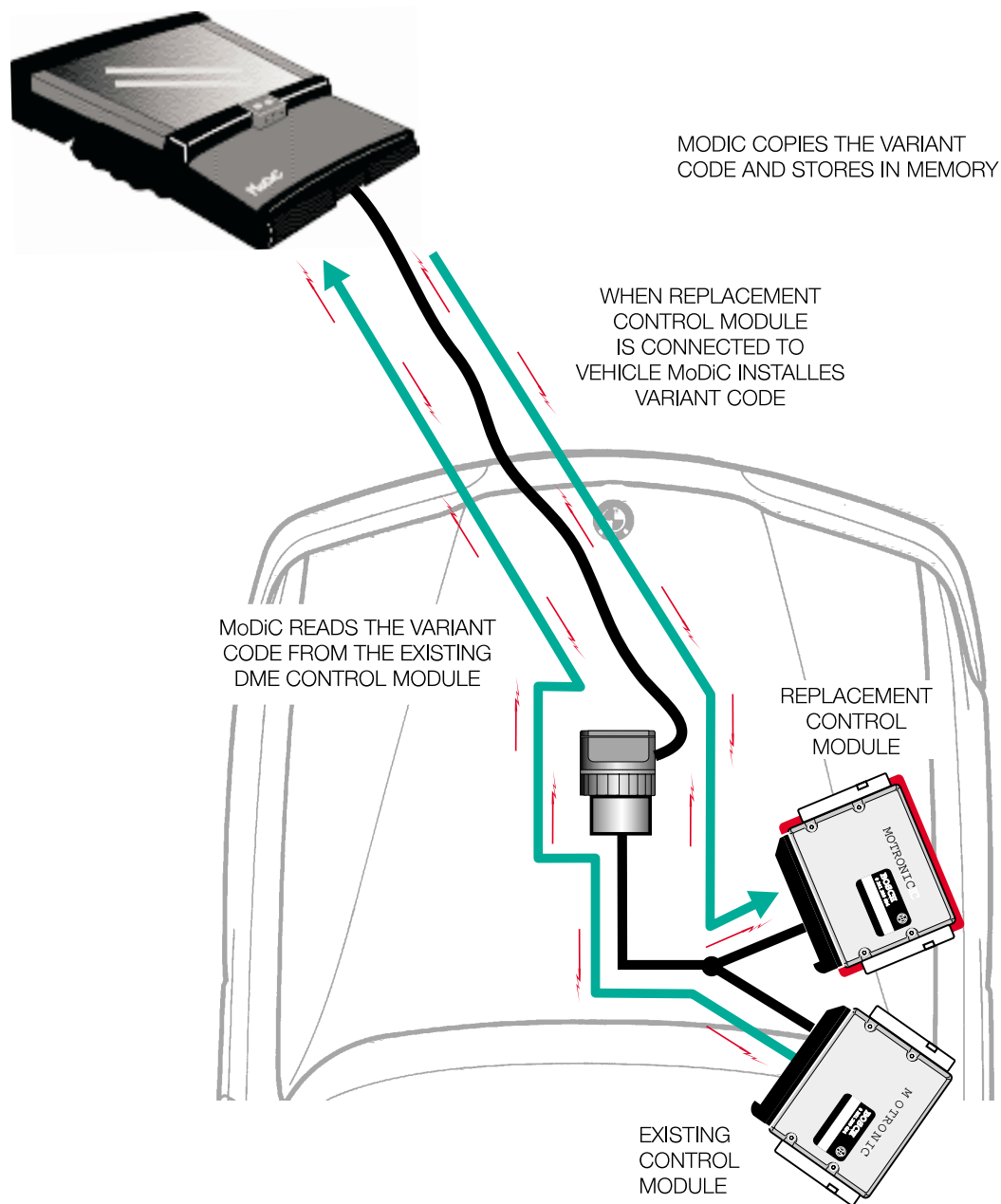

Procedure for Adopting Existing Variant Code

Turn off all loads and always have a BMW battery charger connected during the coding process to maintain proper voltage (12.5V).

1. Connect the DIS/MoDiC to the vehicle's 20 pin diagnostic connector and turn the ignition switch ON. Select Coding and Programming from the DIS/MoDiC start screen or drop down menu.

2. Select **"4 Programming"** and press the right continue arrow.

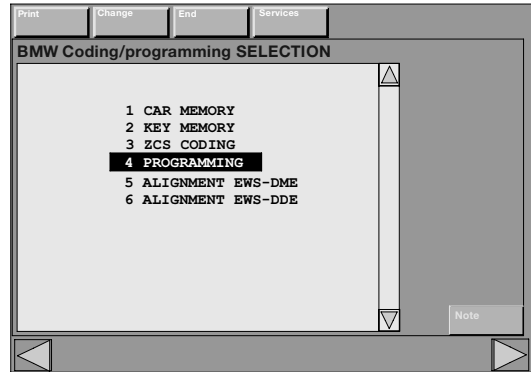

3. From the Coding/Programming selection menu, highlight **"2 DME variant Code"** and press the continue arrow.

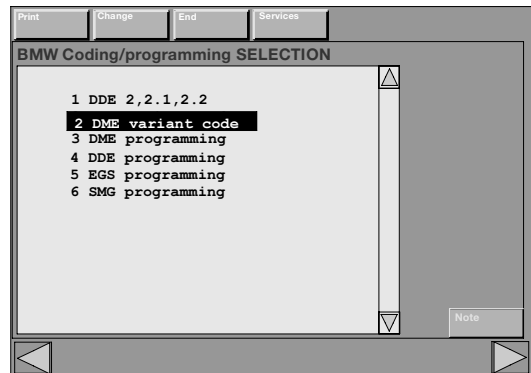

4. Select **"1 Exchange Control Module"** and press the continue button.



5. Select the installed engine group of the vehicle. e.g. M20, M30 etc.

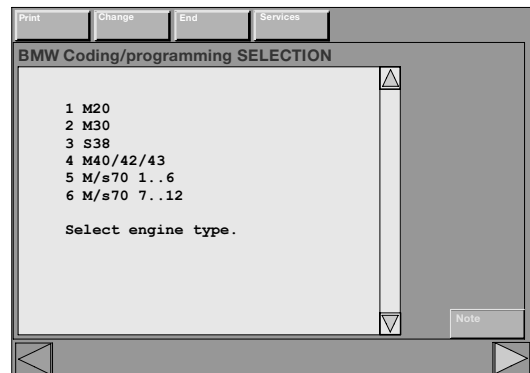

6. Select "1 New Coding" and continue.

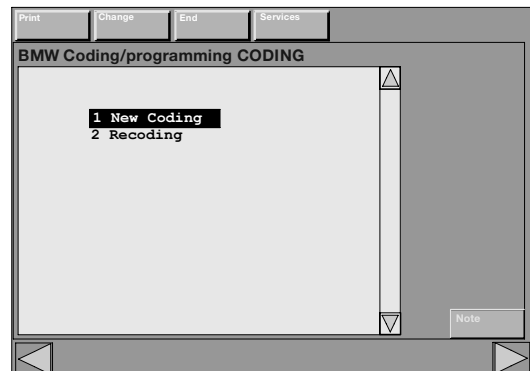

7. Select "1 Adopt code from old control module".

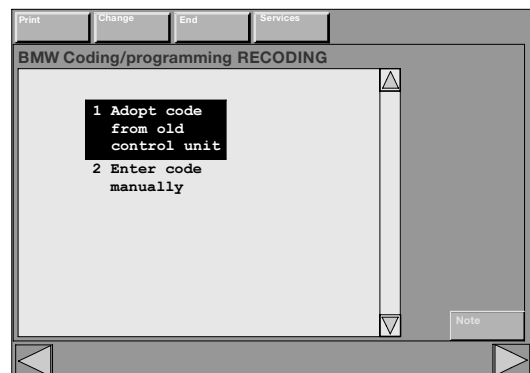

8. Press the "Yes" button to read out code from existing control module.

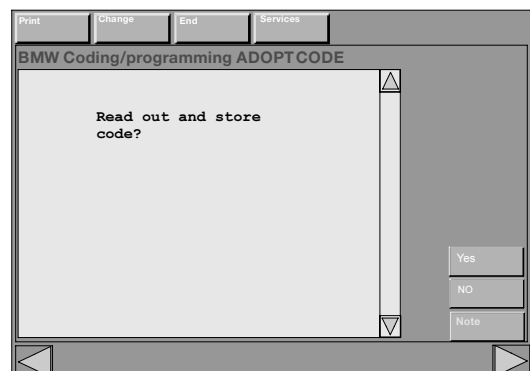

9. The installed variant code will be transferred to the DIS/MoDiC for display and storage.

Do not disconnect the MoDiC from the vehicle diagnostic connector. The stored variant code will be deleted.

10. Turn off the ignition switch and remove the old control module. After double checking the part number of the replacement control module, connect it to the vehicle harness. Turn the ignition switch back on and press the continue arrow.

11. The DIS/MoDiC will display the code for transfer and indicate how many more times the control module can be encoded. Press the “Yes” button to transfer the code.

12. The last screen will indicate that the coding procedure is complete.

NOTE: If the code FF01 is displayed the control module was not properly coded and coding procedure must be repeated (FF01 is a basic control module resident code).

13. Complete a new DME variant code label and place it on the control module.

For vehicles equipped with DME M1.7.2 control modules after 1/95 production, the ISN of a replacement control module must be aligned with the EWS II control module.

This procedure copies the ISN from the new DME control module and installs it into the EWS II control module. If this procedure is not carried out the engine will crank, but will not start.

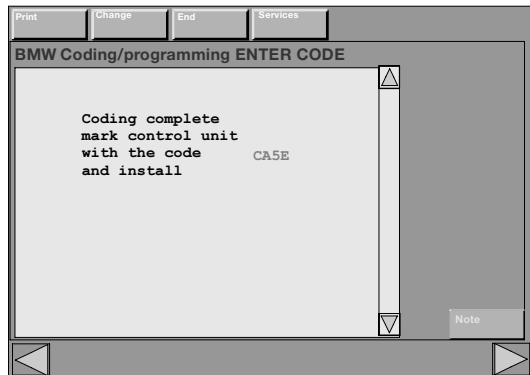
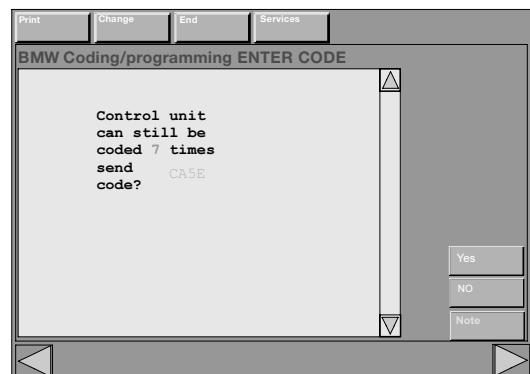
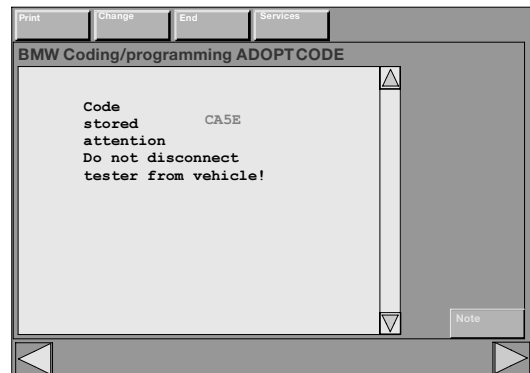

Manually Entering the Variant Code

This method is required if the control module is defective and can not communicate with the DIS/MoDiC over the diagnostic link. The variant code is determined reading the label on the defective control module and double checking it with the published variant codes in SI Bulletin 13 02 90 or in the table on page 32.

Follow steps 1 through 6 and continue below.

7. Select **“2 Enter Code Manually “** and press the enter button.
8. Turn the ignition off and remove the old control module. Install the new control module and turn the ignition back on.
9. Determine the variant code.
10. Carefully enter the code using the on-screen keypad.

When the code is correctly displayed on screen, press the “Yes” button to confirm the entry.

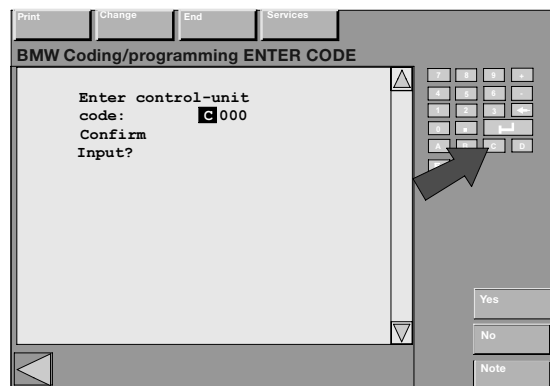
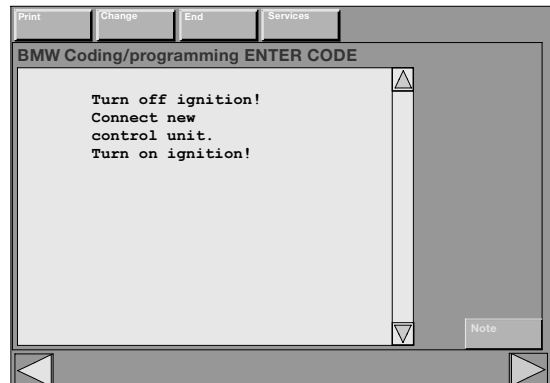
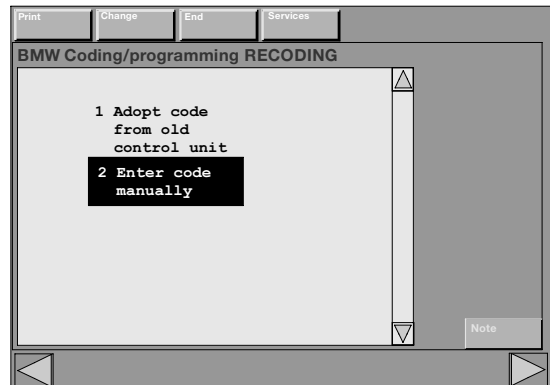

11. The DIS/MoDiC will display the remaining number of times the control module can be encoded. Press the “Yes” button to transfer the code.

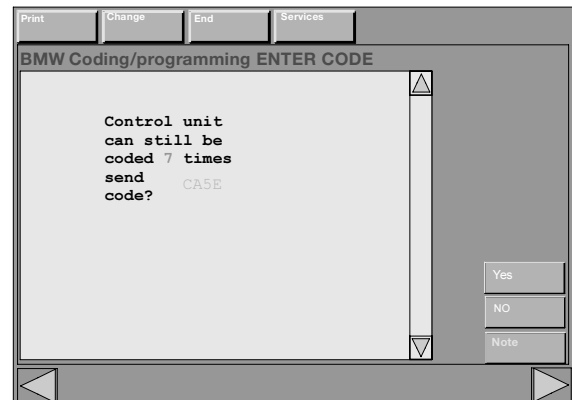

12. Coding is complete. The DIS/MoDiC displays the installed variant code. If the code is displayed as FF01 (basic control module code) the coding procedure must be repeated.

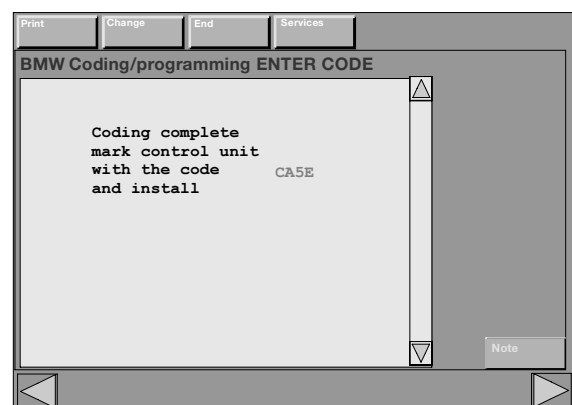

13. Complete a new DME variant code label and place it on the control module.

The coding procedure is complete!

Recoding

The recoding function only applies to vehicles requiring a catalytic converter retrofit. All US vehicles are already equipped with catalytic converters. This function is not required in our market.

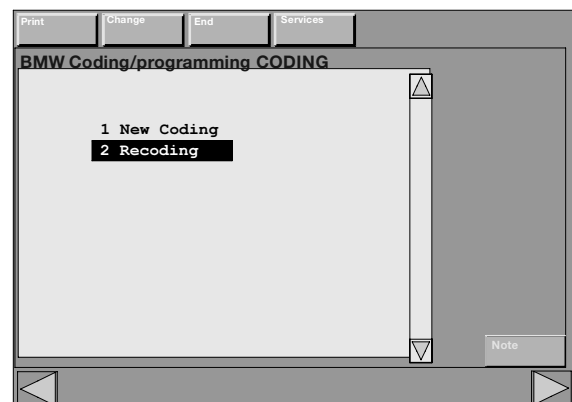

DME Variant Codes

The following table provides a list of all the DME Variant Codes for U.S. Vehicles.

Model and Engine Family	DME Series	Transmission	Variant Code
318i/is (E30) M42B18	M1.7	Manual	801E
318i/is/ (E36) M42B18 DISA	M1.7	Manual	801E
		Automatic	821E
325 (E30) M20B27	M1.1	Manual	C81E
		Automatic	CA1E
325i MY87 (E30) M20B25	M1.1 or M1.3	Manual	C81E
		Automatic	CA1E
325i MY 88 (E30) M20B25	M1.1 or M1.3	Manual	C85E
		Automatic	CA5E
325iX (E30) M20B25	M1.1 or M1.3	Manual	C83E
		Automatic	CA3E
528e (E28) M20B27	M1.1	Manual	C87E
		Automatic	CA7E
525i (E34) M20B25	M1.3	Manual	C89E
		Automatic	CA9E
535i (E34) M30B35	M1.3	Manual	C83E
		Automatic	CB3E
535i w/ASC (E34) M30B35	M1.3	Manual	C83A
		Automatic	CB3A
M5 (E34) S38B36	M1.2	Manual	881E
635Csi (E24) M30B35	M1.1	Manual	C85E
		Automatic	CB5E
635Csi (E24) M30B35	M1.3	Manual	C87E
		Automatic	CB7E
735i/iL (E32) M30B35	M1.1	Manual	C85E
		Automatic	CB5E
735i/iL (E32) M30B35	M1.3	Manual	C85E
		Automatic	CB5E
735i/iL w/ASC (E32) M30B35	M1.3	Automatic	CB5A
750iL (E32) M70B50	M1.2	Automatic	C31A
750iL (E32) M70B50	M1.7	Automatic	C312
850i (E31) M70B50	M1.7	Manual	C052
		Automatic	C352

DME Control Module Programming

DME programming is used to change a “basic control unit” into a “programed control unit” by writing operating instructions onto a blank EPROM. Programming is also used to update an existing DME program by writing additional instructions that compliment the existing software. Programming is used on DME M3.X variants.

Storage of Programming Data

In it's unprogrammed basic state, the EPROM only contains “resident data”. The resident data provides control module/ EPROM identification to the programming software prior to programming.

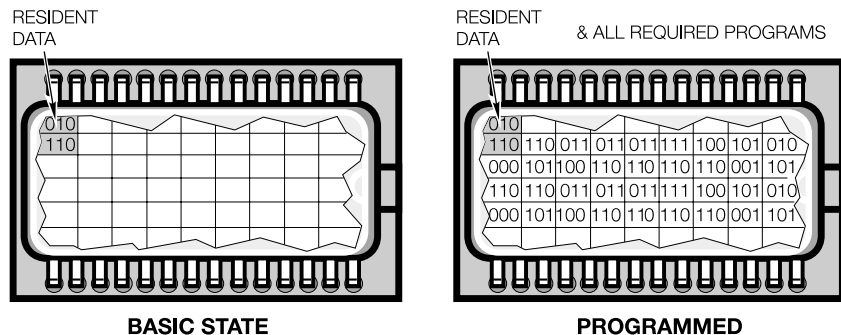

When programmed, the EPROM is filled with the required characteristic maps (ignition timing, injection etc), control module constants, Identification data, etc.

When is programming necessary?

Programming an engine control module is necessary when:

- Installing a replacement basic control module
- Recall or Service Action campaign: This falls into one of the following categories:
 - Program update to existing program
 - Complete programming procedure after EPROM replacement.

Programming a replacement basic control module

Control modules are received from the parts department in the basic state (EPROM loaded only with resident data). These control modules require programming using the DIS/MoDiC and the latest programming software.

Programming Update

Updates are referred to as “Customer Service Measures” in the programming software. The existing program in the control module is amended with an updated program. This new data changes various

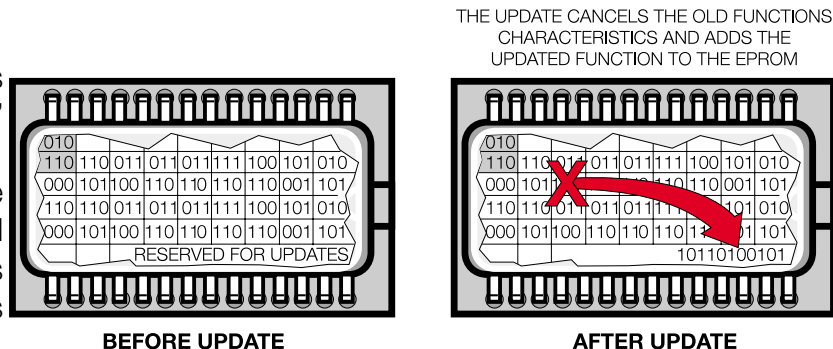

Control Module Identification

It is important to know how to properly identify DME control modules prior to programming. The control modules are identified by:

- BMW Part number
- BMW Hardware number
- Bosch Hardware number

These numbers are displayed in the following locations:

- Control module ID label.
- Control module ID display using the Diagnostic program.

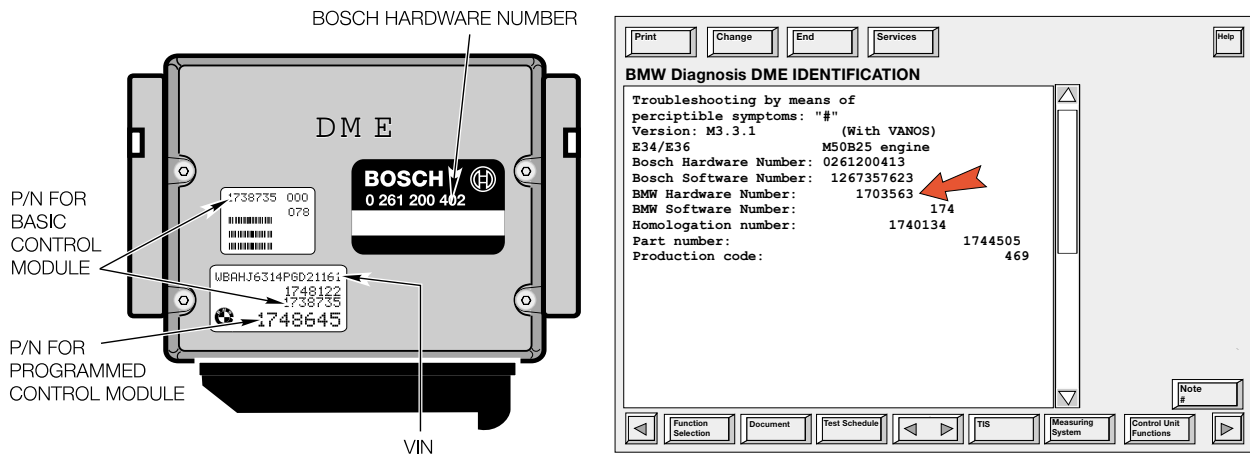

Part Number Basic Control Module

This number refers to the part number of the control unit without any data status.

Part Number Programmed Control Module

This number refers to the part number of a factory programmed module that includes the data status.

When the determination information is stored in the DIS/MoDiC memory, the programming software:

- Suggests updates for the connected control module (Customer service Measure)
- Provides the part number for the replacement
 - Basic Control Module
 - EPROM
- Reuses the data when the replacement control module or EPROM is programmed as long as the DIS/MoDiC is not used for another purpose after the determination process.

There are two determination methods: automatic and manual.

Automatic: The software performs this automatically. During the automatic determination the VIN is displayed.

If the VIN matches the connected vehicle press the “Yes” button.

If the VIN does not match the connected vehicle the installed control module may have been previously replaced. Press the “No” button. Manually enter the correct VIN from the vehicle and press “Yes”.

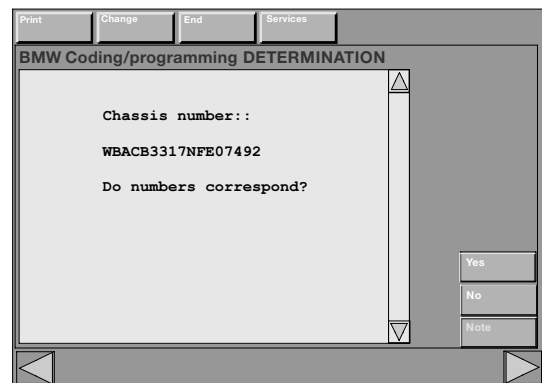

The software compares the electronic part number of the installed EPROM with a list of replacements. This is a part number for a replacement basic control module or an EPROM depending on the procedure being performed.

There are two columns of part numbers in the display. The left column is new basic control modules and the right column is remanufactured basic control modules. Always order using the part number from the right column. Proceed with the reprogramming procedure covered further on.

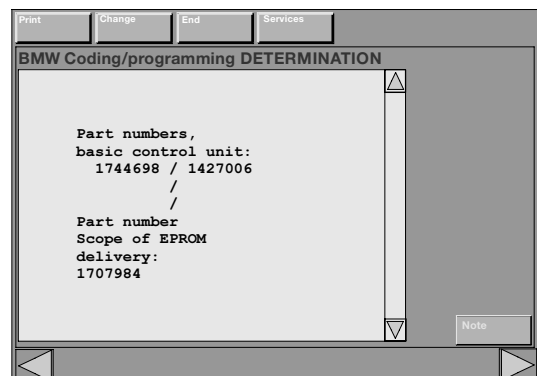

If the MoDiC displays the message **“No Substitute found”** continue on to a manual determination.

Manual determination is performed by pressing “No” to the displayed question, “Is the faulty control module still in the car”.

Manual: A manual determination must be performed if:

- The control module cannot communicate with the DIS/MoDiC.
- The software does not recognize the DME identification data.
- The DIS/MoDiC cannot find a replacement number stored in memory during an automatic determination.

Manual determination is carried out by entering:

- Part number of the basic programmable control module.
- VIN of the vehicle.
- Part number of the factory programmed control module.

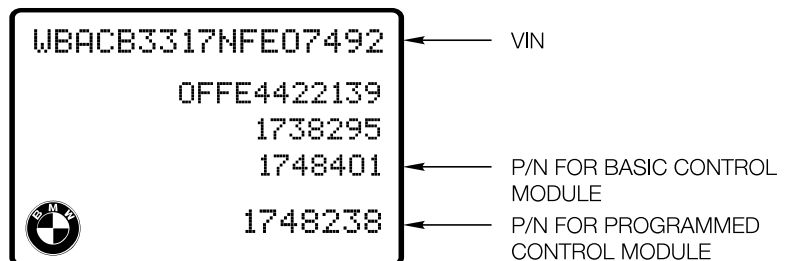

These numbers are found on the I.D. label of the DME control module.

The DIS/MoDiC will display the part numbers for the replacement part. Order the component using the MoDiC supplied part number (only use number in right column) and proceed with the reprogramming procedure.

If the display states: **“No Programming data available for this SG version.”**, or **“Incorrect part number for programmed control unit?”**

Double check the control module label for an incorrect VIN. This control module could have been incorrectly programmed in a previous programming campaign or control module replacement.

If after both the automatic and manual determinations have been performed and the message **“No Substitute found”** is still displayed the following maybe the cause:

- A part number supersession has occurred since the programming software was issued (**thoroughly review the Service Information bulletin for alternative part numbers to be entered**).
- The currently installed control module was incorrectly programmed in a previous programming procedure.

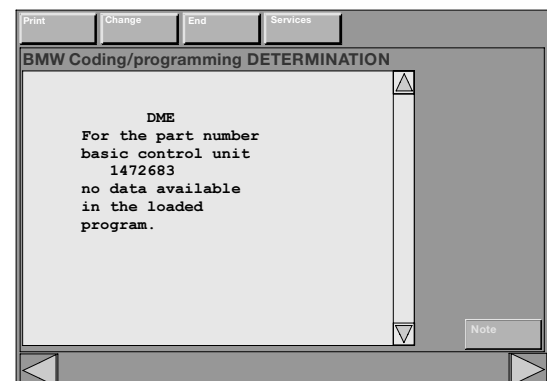
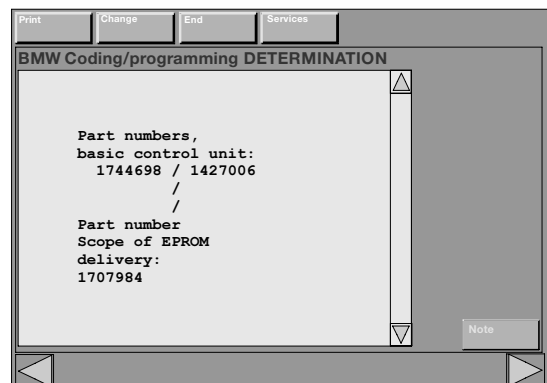

Programming Procedures for “Customer Service Measures”

Prior to any type of programming, make sure the DME fault memory is cleared and vehicle battery is connected to a BMW battery charger with stabilized 12.5V!

This procedure is for special program updates only. The software contains the update information that is added to the existing control module EPROM.

1. Connect the DIS/MoDiC to the diagnostic connector. Turn the ignition switch ON.

2. Select Coding and Programming from the DIS/MoDiC start screen or “Change” drop down menu.

3. Select “**3 DME Programming**” and press continue.

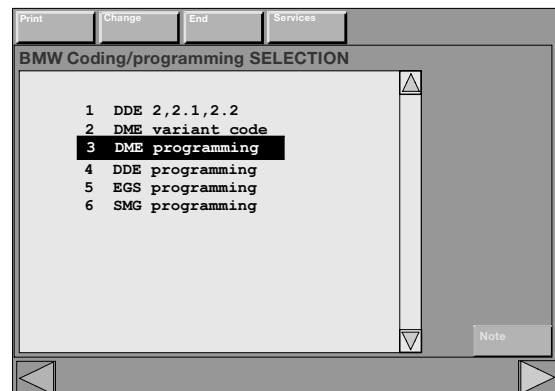

4. Select “**1 Determine Customer Service Measures**” and press the continue arrow.

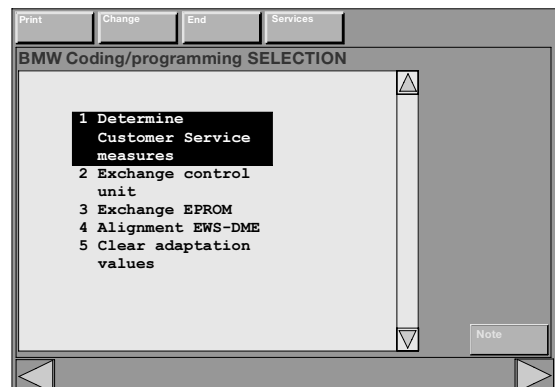

5. “Engine off, Ignition On”.

6. Press the “Yes” button to start automatic determination.

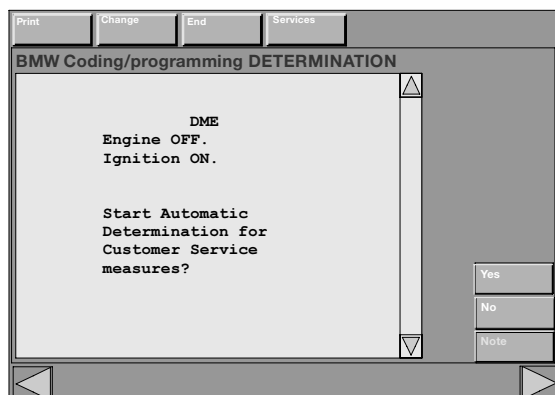

7. The VIN is displayed. If the displayed VIN matches the vehicle press the “Yes” button. Press the “No” button if it does not match and enter the VIN manually then press the “Yes” button.

8. If there are no service measures available for the control module the message “**No customer service measures available for this control module**” will be displayed.

If the software contains a service measure, select the number and press the enter button.

9. The message “... **service measure was selected**” will display. Press the “Yes” button to start the update.

10. When the update is complete the DIS/MoDiC will display “**Service Measure update complete**”.

Programming Procedures for “Exchange Control Unit”.

Select this to program a replacement Basic DME control module.

Prior to any type of programming, make sure the DME fault memory is cleared and vehicle battery is connected to a BMW battery charger with stabilized 12.5V!

1. From the Programming selection menu select “**2 Exchange Control unit**” and press continue.

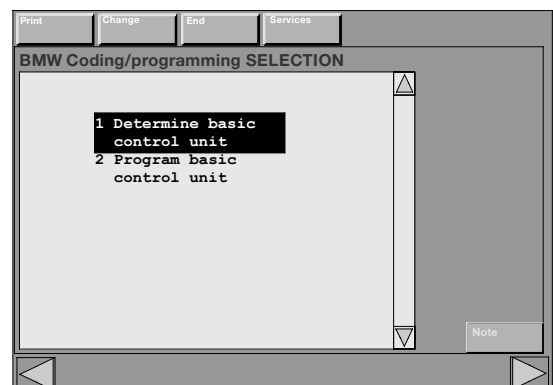
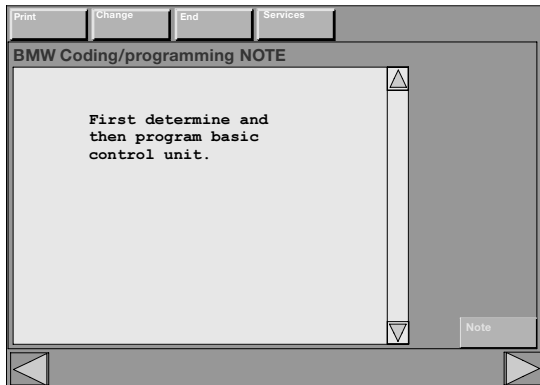
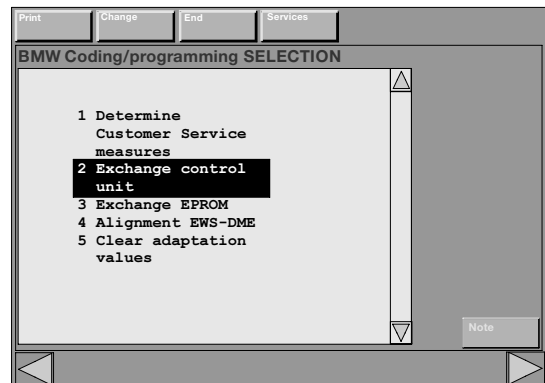

2. Press “**1 Determine Basic Control Module**” and continue.

3. Press “Yes” to confirm control module is still in the vehicle.

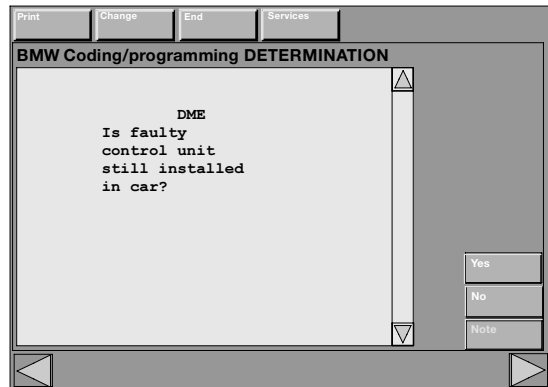

4. Turn on the ignition and press the “Yes” button to start the automatic determination.

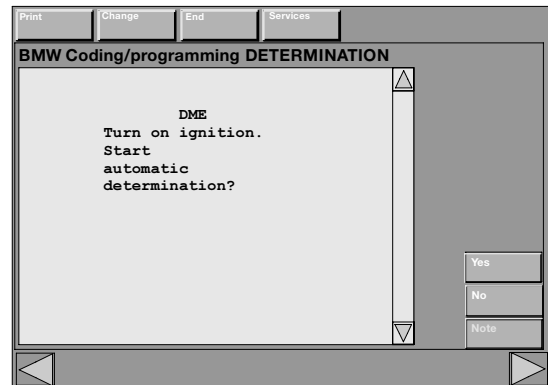

5. If the chassis numbers are correct press the “Yes” button. If they are different press the “No” button and enter it manually.

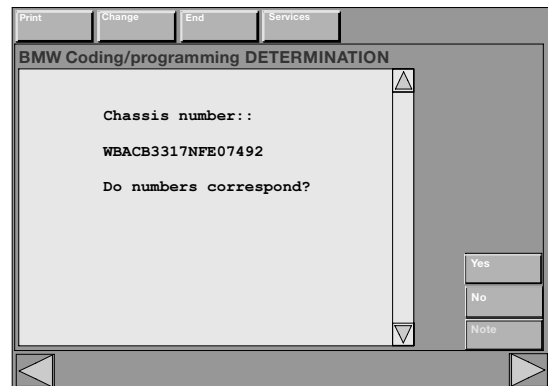

6. The programming software provides the replacement control module part numbers in the display. The part number on the left is for a new control module. The number on the right is for a remanufactured control module.

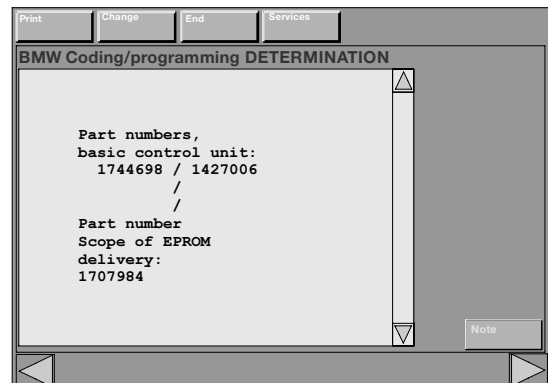

Always order the remanufactured number.

7 Obtain the exchange control module and install it in the car. The vehicle data will remain stored in the DIS/MoDiC as long as it is not used for any other purpose. Press the back arrow to return to the selection menu.

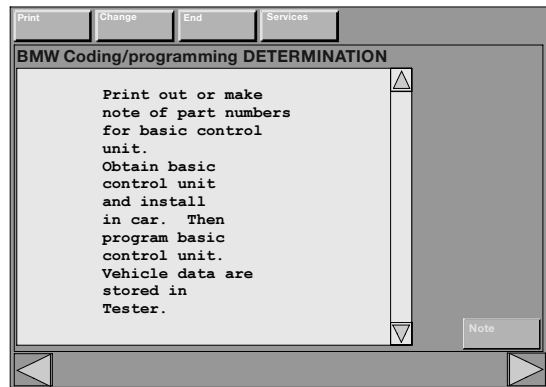

9. Select **“2 Program control module”** and press continue.

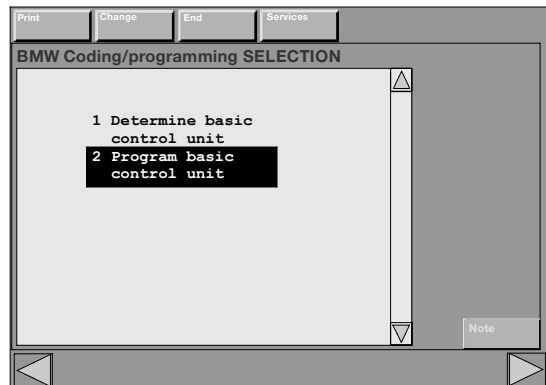

10. Enter the last 7 digits of the VIN and press the “YES” button.

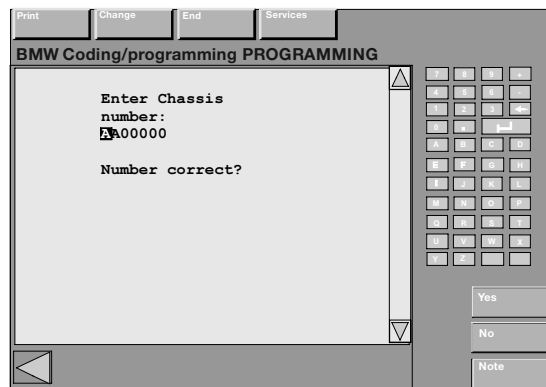

11. Press the “YES” button to start automatic programming.

The screen will indicate when the programming is complete.

12. Carry out DME-EWS alignment if necessary and clear any faults stored in the DME that may have occurred during the programming process.

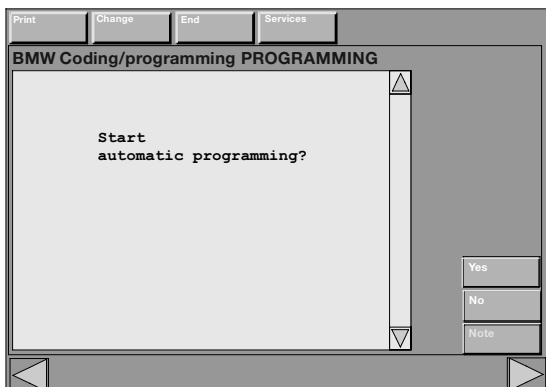

Programming Procedures for “Exchange EPROM”

Select this to program a replacement control module EPROM.

Prior to any type of programming, make sure the DME fault memory is cleared and vehicle battery is connected to a BMW battery charger with stabilized 12.5V!

1. From the Programming selection menu select **“3 Exchange EPROM”** and press continue.

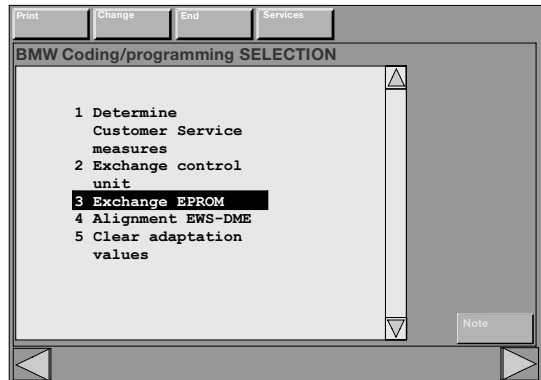

2. Press **“1 Determine EPROM”** and press the enter button.

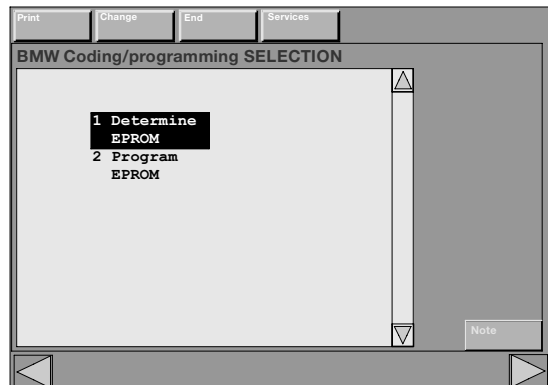
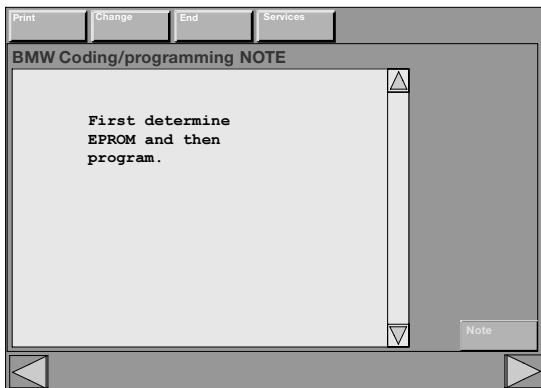

3. Press Y to confirm old EPROM is still in car.



4. Turn on ignition and press the “Yes” button to start the automatic determination.

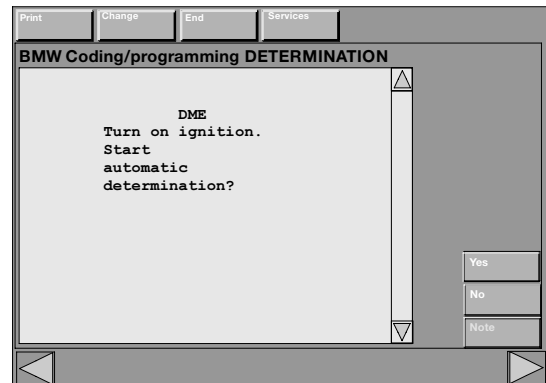

5. If chassis numbers are correct press the “Yes” button.

If they are different press the “No” button and enter the VIN manually, then press the “Yes” button.

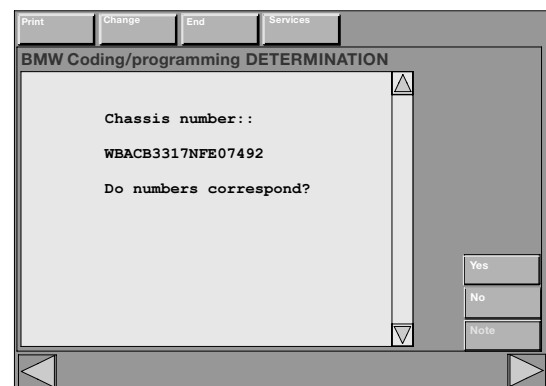

6. The DIS/MoDiC provides the replacement EPROM part numbers in the display.
7. Obtain the EPROM and follow Service Bulletin covering specific details pertaining to the EPROM replacement procedure.

The vehicle data will remain stored in the MoDiC as long as it is not used for any other purpose. Press the up arrow to return to the selection menu.



8. Select “**Program EPROM**” and press the enter button.

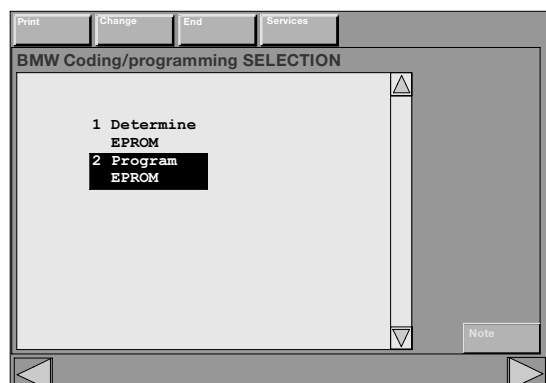

9. Enter the last 7 digits of the VIN and press the “Yes” button.

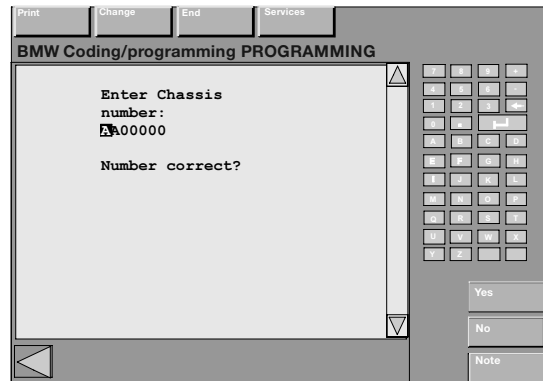

10. Press the “Yes” button to start automatic programming.

The screen will indicate when the programming is complete.

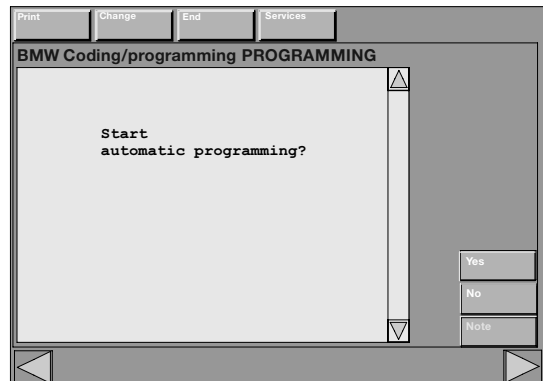

Alignment of DME-EWS

For vehicles equipped with DME control modules after 1/95 production, the ISN of a replacement control module must be aligned with the EWS control module.

This procedure copies the ISN from the new DME control module and installs it into the EWS control module. If this procedure is not carried out the engine will crank, but will not start.

Interrogate the DME fault memory and clear any faults stored during the programming process.

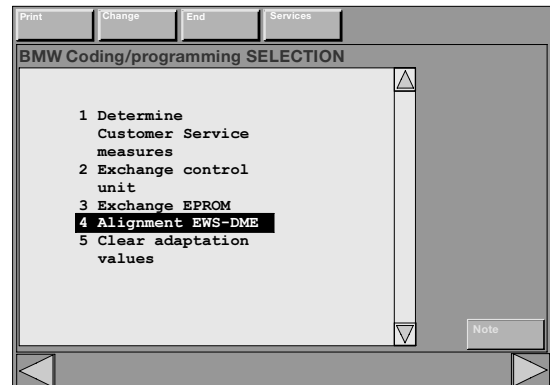

Flash Programming

The procedure to program Flash Programmable control modules follows all of the preceding steps describing “Exchange control unit”. EPROMs are not exchanged for Flash programmable control modules, they have a soldered in, non removable EEPROM.

When connected to the diagnostic connector, the DIS/MoDiC utilize the loaded programming software to communicate with the engine or transmission control module to establish an “authorized unlocked link” with the control module. This link is known as the “seed/key relationship” and is used for the purpose of programming only. The relationship is established as follows:

- The DIS/MoDiC initiates the relationship by requesting the “seed” data from the control module.
- The control module responds by sending the seed to the DIS/MoDiC.
- Based on the received seed, the DIS/MoDiC generates the “key” data and sends it back to the control module.
- The control module then compares the received “key” data with a previously stored value. If they are identical the control module will “unlock” in preparation of programming and send an acknowledgement to the DIS/MoDiC for continuation. If the “key” data is not correct, the control module will discontinue the relationship preventing an “unauthorized unlocking” as a security measure.

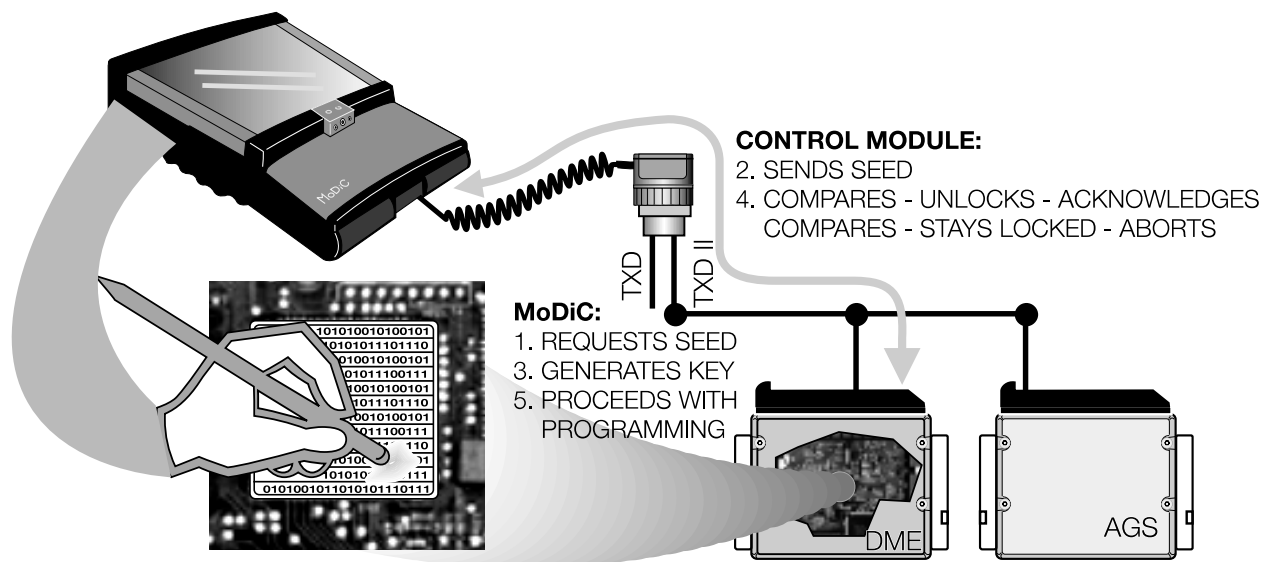

- The control module then allows the DIS/MoDiC to erase certain areas of the EEPROM to provide space for new data when an update is being performed or program all of the data for when a new basic module is being installed into a vehicle.

Procedure for Flash Programming a Control Unit.

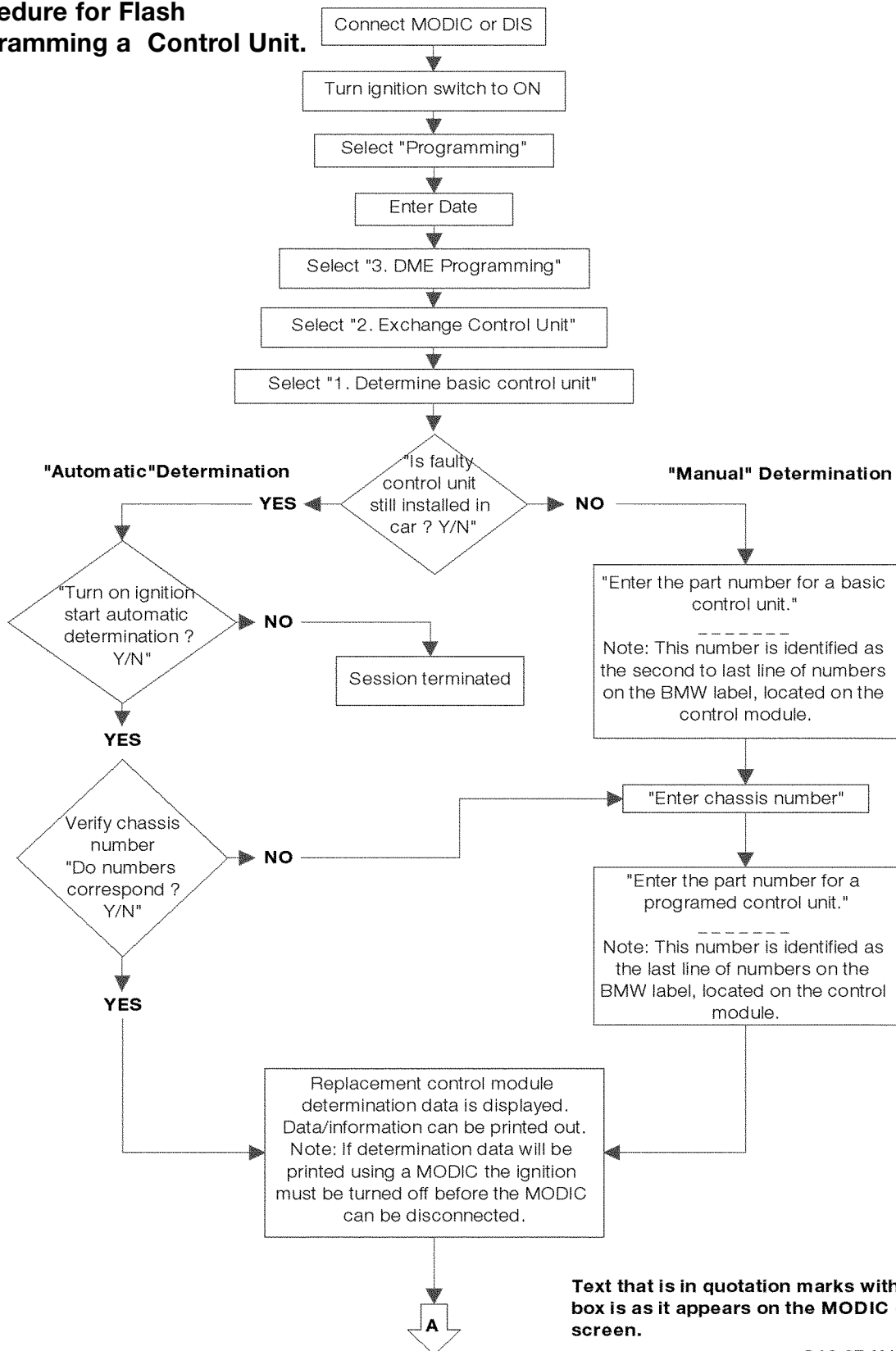

S12 97 U12

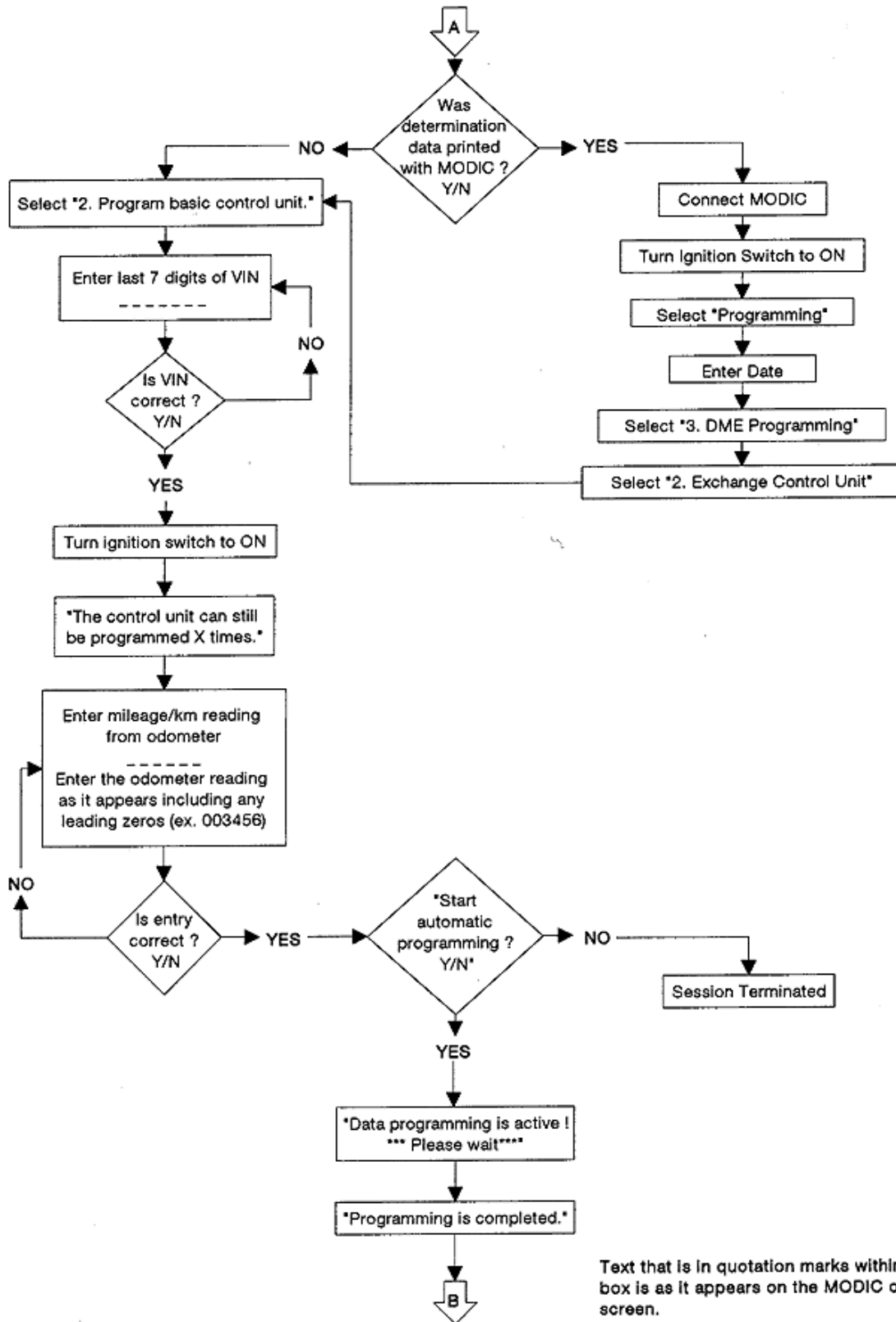

Text that is in quotation marks within each box is as it appears on the MODIC or DIS screen.

S12 97 U13

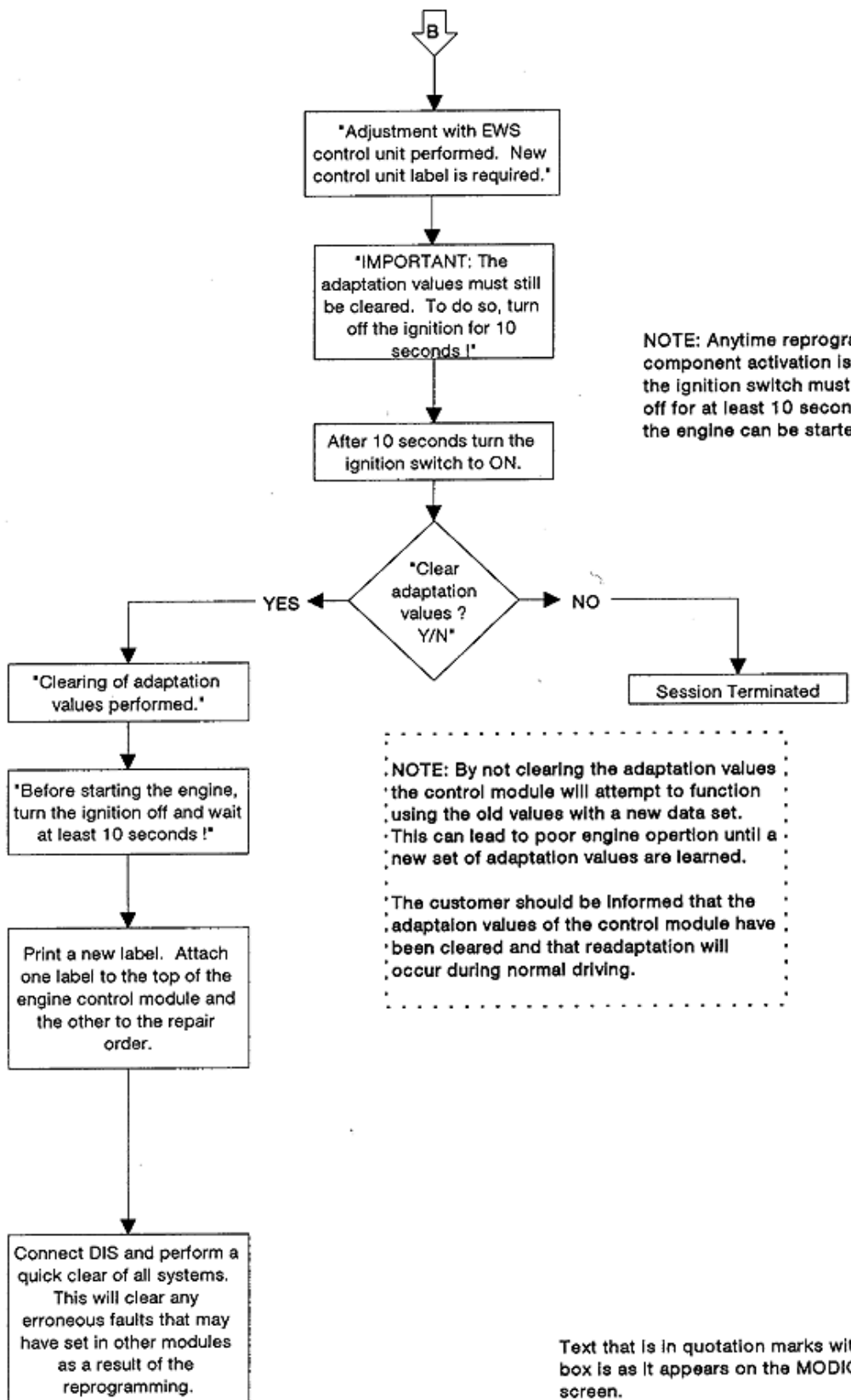

S12 97 U14

Additional Steps to be Taken into Consideration

Follow the additional information listed below when flash programming an engine or transmission control module.

- **Sufficient battery voltage is critical** when flash programming a control module. If the battery voltage drops below a certain level during programming, the session will terminate prior to completion. If the vehicle has been in the workshop for diagnosis with the ignition key on for long periods of time, the battery voltage is most likely deficient.

Verify the battery voltage prior to programming, if necessary connect a battery charger to the vehicle prior to starting flash programming. Do not connect the charger during the actual procedure. This could cause a voltage spike to occur which will also abort the programming procedure.

Connect the charger before you start programming!

- Flash Programmable control modules can be programmed up to 13 times. The remaining programming sessions is displayed during the programming procedure.
- The program will automatically realign the EWS & DME. This function can also be found either in the Engine control module programming software or ZCS coding of the EWS.
- Depending on the level of programming data, the procedure can take between 2 and 15 minutes.
- **After programming, clear the control module's adaptation values.** The programming software will automatically provide instructions. Clearing the adaptation values can also be found in the Service Functions menu of the diagnostic software in the DIS. The control module will quickly re-adapt to the system storing new values during a test drive.
- **After programming, clear all vehicle control modules that interface with the newly programmed control module.** The programming procedure can cause other interfacing control modules (AGS, ASC, etc) to store erroneous faults. When programming is completed, perform a quick test with the DIS to determine if any faults have been stored. Clear all vehicle control module fault memories to prevent any unnecessary future diagnosis.

Review Questions

1. What was the principle factor in the reason for workshop coding and programming?
_____ List the available coding and
programming software. _____

2. What does “Flash Programming” mean and how do earlier DME control units differ?

3. Where is the ZCS stored in the vehicle? How can it be retrieved? _____

4. Which control modules may require that the ZCS be entered manually when coding a
replacement part? _____

5. What is the purpose of the “Conversion” path in the ZCS coding software?

6. Under what circumstance is it acceptable to enter a variant code in a DME that is not
for the particular vehicle type? _____
How many times may a DME be variant coded? _____

7. Why does the re-programming of a M3.X DME require the EPROM be replaced?

8. Explain the difference between the “part number for a basic control module” and the
“part number for a programmed control module” Where can these numbers be found?

